

# BÖLLHOFF

## AMTEC®

Precision thread inserts for after-moulding joining in plastic components

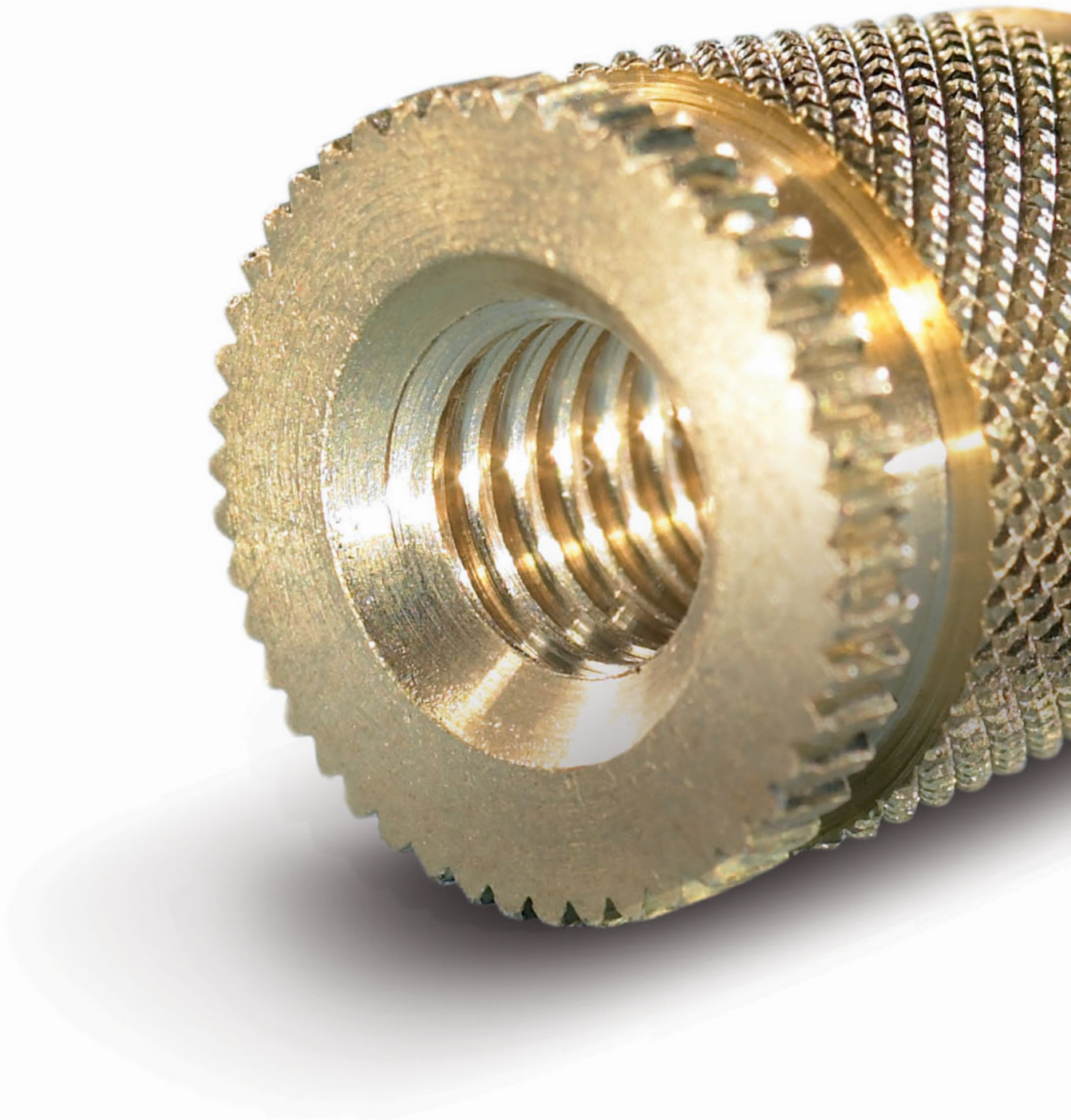



	Page
AMTEC® High-strength thread inserts for plastic components	5
The advantages – an overview	5
Selection matrix for AMTEC® thread inserts	6
Selection matrix for installation methods	7

## Variants

### Thread inserts for thermal installation

HITSERT® 2	10
HITSERT® Screwlock	12
HITSERT® 3	13
HITSERT®	14
SONICSERT®	16
Installation methods	20
Installation machines	21

### Thread inserts for self-tapping insertion

QUICKSERT®	26
QUICKSERT® Hex	30
QUICKSERT® Plus	31
Installation tools	33

### Thread inserts for expansion anchoring

EXPANSIONSERT 1	38
EXPANSIONSERT 2	40
SPREDSERT® 1	41
SPREDSERT® 2	42
SPREDSERT® 1 and 2 technical data	43
SPREDSERT® with retaining flange	45
QUICKSERT® type 1230	46
Installation tools	48
Potential and realised applications	50

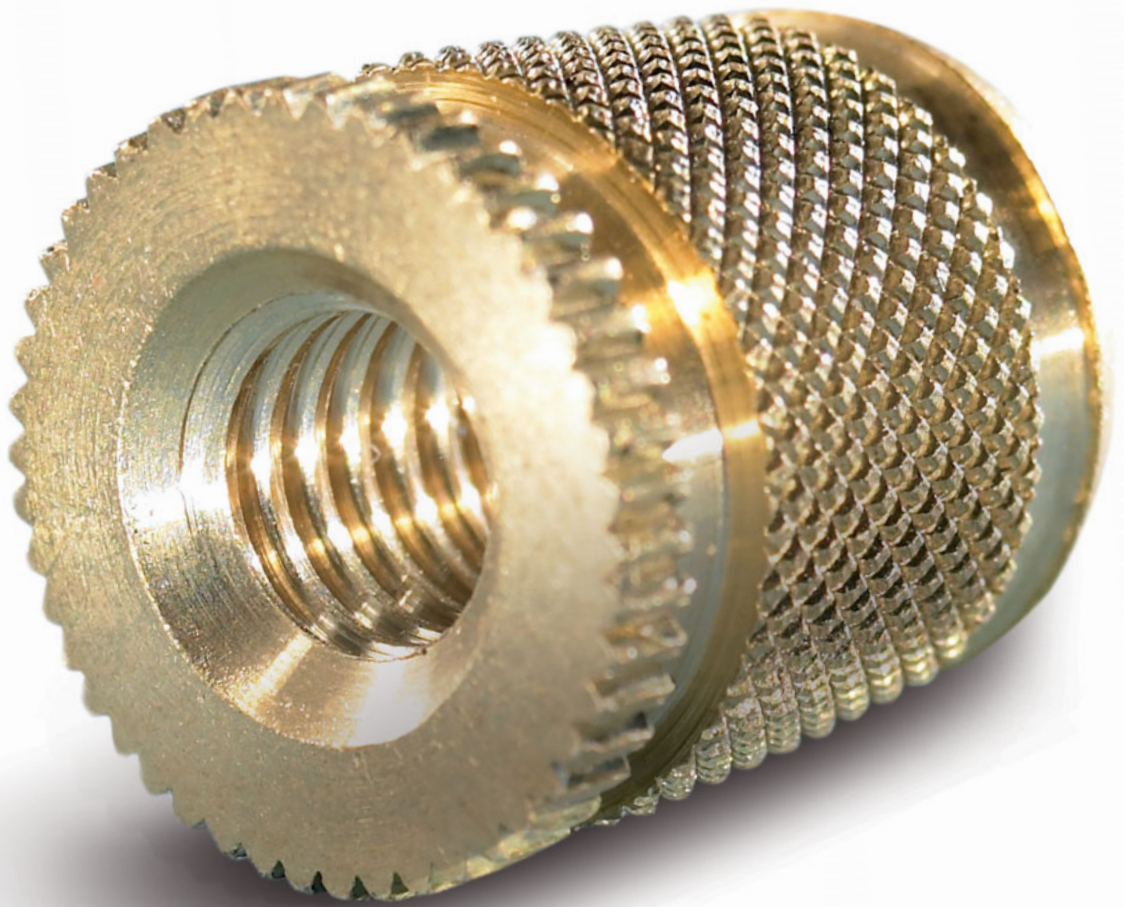

Under the name of AMTEC®, Böllhoff offers thread inserts as well as the respective assembly systems for the after-moulding technology. The thread inserts are especially designed for after-moulding insertion. The result are wear-free, high-strength threads in your high-quality plastic components.

They are suited for the installation in mouldings of thermoset, thermoplastic or reaction resin materials (also filled or foamed).

**There are various installation methods:**

- Thermal installation – heated element welding, electromagnetic resistance welding
- Ultrasonic welding
- Expansion anchoring
- Self-tapping insertion
- Pressing

**To apply the most efficient installation method in every case we offer:**

- Manual installation tools
- Semi-automatic tools
- Automatic machines: from multiple installation for large-scale production to the freely programmable CNC-controlled installation machine for frequently varying components.

Feel free to contact us for the development and production of customised thread inserts and installation devices.

**The advantages – an overview**

- Shorter moulding cycles, automatic injection moulding without insertion of metal parts
- No risk of damage to the injection mould from falling out metal parts
- No stress cracks resulting from hardly controllable shrinkage around the metal part
- Advantages over self-tapping screws since the joint can be detached as often as required without damaging the thread
- Safe, stress-free anchorage with high pull-out and torsion values
- Reduction of manufacturing costs for the plastic parts and increased quality of your products
- Low-maintenance machines in combination with innovative control concepts (service expenses reduced to a minimum)

# Selection matrix for **AMTEC®** thread inserts

Requirements Specifications	HITSERT® 2	HITSERT® 3	SONICSERT®	QUICKSERT® Plus	QUICKSERT®, QUICKSERT® Hex self-tapping	QUICKSERT® Expansion type 1230	EXPANSION-SERT 1	EXPANSION-SERT 2	SPREDSERT®
-----------------------------	------------	------------	------------	-----------------	---	--------------------------------	------------------	------------------	------------

## Suitability for different structural materials

Thermoplastics	++	++	++	++	+	+	0	exception	Type 1/ with retaining flange +
Thermosets	--	-	--	--	++	+	+	--	Type 2/ with retaining flange +
Foams	--	--	--	-	0	-	--	+	--
Elastomers	--	--	--	-	0	--	--	+	--
Minimum installation effort (machine technology)	thermal installation machine (smallest quantities with soldering iron)	soldering iron, screwdriver, toggle press	ultrasonic welding machine	manual installation tool, screwdriver	manual installation tool, screwdriver	spindle lifting tool (possibly press)	manual installation mandrel	manual installation mandrel	manual installation mandrel
Recommended wall thicknesses (qualitative comparison: 1 = small, 4 = large)	1	1	2	2	3	4	4	4	3
Interference fit values in identical thermoplastics	100 %	100 % for thermal installation and tapping insertion, 70 % for pressing	80 %	110 %	120 %	100 %	60 %	-	50 %

## Special requirements

Tightness	with O-ring (realised)	with O-ring (realised)	with O-ring (producible)	no	no	-	no	no	no
Bolt thread	yes		yes	no	no	-	no	no	no
Through hole	yes	yes	yes	no	no		no	no	no
Other	By 8° taper angle - self-centering - low-stress	seal inserts for variable processing		chipless embedding		also suited for light metals	easy installation		cost-effective
This catalogue, page	10	13	16	31	26/30	46	38	40	41

-- unsuited / - limited suitability / 0 satisfactory / + well suited / ++ very well suited

**i** Note regarding "Interference fit values in identical thermoplastics":  
The specified values relate to a HITSERT®2 in PA GF.

**i** For in-moulding (in-moulding of thread inserts), we offer our IMTEC® technology.  
For the installation in composite components (CFRP), we offer the IMTEC® CO.

## Selection matrix for installation methods

To meet the generally high requirements for the joining technology, fasteners and assembly systems must be perfectly designed and also match perfectly. That is why we, as a specialist in the joining and assembly technology, cooperate with KVT Bielefeld GmbH, the specialist in welding of plastics, in the field of embedding thread inserts.

Installation methods	Realisable sizes	Installation time	Materials	Size	Installation accuracy			Special features
					< 0.05	+/- 0.1	≥ 0.2	
<b>ERW</b> electromagnetic resistance welding	M 1.4 – M 40	approx. 3 seconds (for size M5)	thermoplastics, thermoplastic elastomers	≤ M 3	++	++	++	<ul style="list-style-type: none"> <li>■ Low-stress</li> <li>■ Multiple installation possible</li> <li>■ Especially for thread inserts &lt; M 2 as well as thread inserts with sealing rings</li> <li>■ Single-phase or two-phase process can be selected</li> </ul>
				M 4 – M 6	++	++	++	
				≥ M 8	++	++	++	
<b>HEW</b> heated element welding	M 2 – M 8	approx. 3–4 seconds (for size M4)	thermoplastics, thermoplastic elastomers	≤ M 3	--	++	++	<ul style="list-style-type: none"> <li>■ Low-stress</li> <li>■ Multiple installation possible</li> <li>■ Well suited for threaded bolts</li> <li>■ Easy retooling for different sizes</li> </ul>
				M 4 – M 6	--	++	++	
				≥ M 8	--	+	+	
<b>USW</b> ultrasonic welding	M 2 – M 6	approx. 2 seconds	thermoplastics	≤ M 3	--	0	++	<ul style="list-style-type: none"> <li>■ High noise emission during the installation of metal thread inserts</li> <li>■ Heavy abrasion of material during the installation of metal thread inserts</li> <li>■ Unsuitable for threaded bolts</li> <li>■ Easy retooling for different sizes</li> </ul>
				M 4 – M 6	--	0	++	
				sizes ≥ M 8: individual testing by the machine manufacturer required				

-- unsuited / - limited suitability / 0 satisfactory / + well suited / ++ very well suited

All measures in mm.



KVT Bielefeld GmbH, a company of the Dukane Corporation, Rabenhof 18 a, 33609 Bielefeld, Germany  
phone: +49 (0)521/932070, e-mail: info@kvt-bielefeld.de





	Page
AMTEC® High-strength thread inserts for plastic components	5
The advantages – an overview	5
Selection matrix for AMTEC® thread inserts	6
Selection matrix for installation methods	7

## Variants

### Thread inserts for thermal installation

HITSERT® 2	10
HITSERT® Screwlock	12
HITSERT® 3	13
HITSERT®	14
SONICSERT®	16
Installation methods	20
Installation machines	21

### Thread inserts for self-tapping insertion

QUICKSERT®	26
QUICKSERT® Hex	30
QUICKSERT® Plus	31
Installation tools	33

### Thread inserts for expansion anchoring

EXPANSIONSERT 1	38
EXPANSIONSERT 2	40
SPREDSERT® 1	41
SPREDSERT® 2	42
SPREDSERT® 1 and 2 technical data	43
SPREDSERT® with retaining flange	45
QUICKSERT® type 1230	46
Installation tools	48
Potential and realised applications	50



# The variants – thread inserts for thermal installation **HITSERT® 2**



## Your advantages

- Ideal for thermoplastic components
- Especially designed for thermal installation and inductive insertion
- Screw-locked and low-stress anchoring
- High pull-out values
- Efficient installation with manual, semi-automatic installation machines or automatic machines with preheating device

## The principle

The HITsert® 2 thread insert is heated to the melting temperature of the plastic. From the heat transfer during insertion, the plastic is temporarily plasticised and flows into the undercut of the thread insert. During cooling, a high interference fit is achieved while the plastic component is only under low stress.



## Technical data

Material: **brass CuZn38Pb2** (compliant with EU 2000/53) / **CuZn39Pb3** (steel 1.0718 11SMnPb30 as an option; surface: to be agreed)

Type 0932

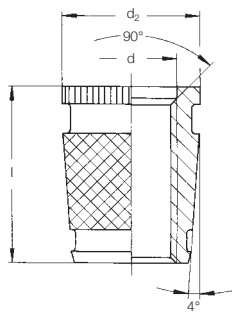

Type 0931<sup>®</sup>

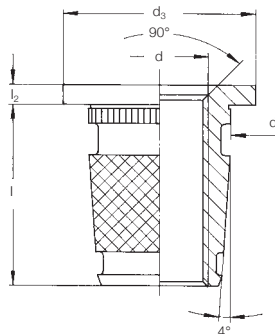

Mounting hole<sup>®</sup>

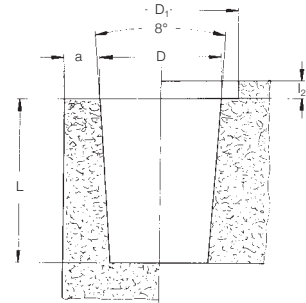

For installation tools and machines, please see pages 21–23

d	Type 0932 item code	Type 0931 <sup>®</sup> item code	l	l <sub>2</sub>	d <sub>2</sub>	d <sub>3</sub>	D <sup>+0.1</sup>	D <sub>1</sub>	L <sub>min.</sub>	a <sub>min.</sub>
M 2	0932 102 0005	0931 102 0056	5.0	0.6	4.1	5.0	3.8	5.2	6.0	1.5
M 2.5	0932 125 0005	0931 125 0056	5.0	0.6	4.1	6.0	3.8	6.2	6.0	1.5
M 3	0932 103 0005	–	5.0	–	4.7	–	4.4	6.2	6.0	1.8
	0932 103 0055	0931 103 0061	5.5	0.6	4.7	6.0	4.4	6.2	6.5	1.8
M 3.5	0932 135 0006	0931 135 0068	6.0	0.8	5.5	7.0	5.2	7.2	7.0	1.8
M 4	0932 104 0006	–	6.0	–	5.9	–	5.8	8.2	7.0	2.0
	0932 104 0075	0931 104 0083	7.5	0.8	5.9	8.0	5.8	8.2	8.5	2.0
M 5	0932 105 0007	–	7.0	–	7.0	–	6.9	8.7	8.0	2.0
	0932 105 0009	0931 105 0010	9.0	1.0	7.0	8.5	6.9	8.7	10.0	2.5
M 6	0932 106 0009	–	9.0	–	8.6	–	8.5	10.2	10.0	2.5
	0932 106 0010	0931 106 0011	10.0	1.0	8.6	10.0	8.5	10.2	11.0	2.5
M 8	0932 108 0012	0931 108 0013	12.0	1.0	11.1	12.0	10.9	12.2	13.0	3.0

Metric ISO thread according to DIN 13–6H. Technical changes reserved. All measures in mm.

<sup>®</sup> Guideline values: depend on the moulding material, may have to be changed after installation tests.

<sup>®</sup> The flange has a large contact surface and thus reduces the surface pressure. Minimum quantity on request.

Other sizes, special designs and materials on request.

**Type 0940**

**Type 0941®**

**Mounting hole®**

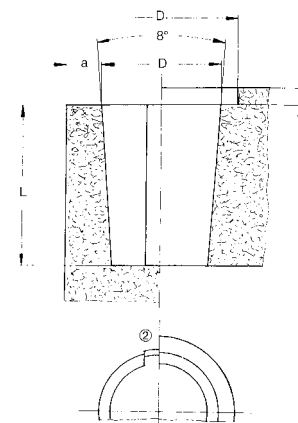
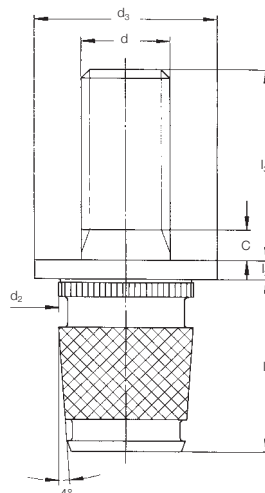
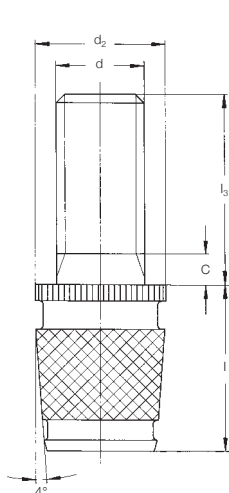

For installation tools and machines, please see pages 21-23

d	Type 0940 item code	Type 0941® item code	l	l <sub>3</sub>	l <sub>2</sub>	d <sub>2</sub>	d <sub>3</sub> ®	D <sup>+0.1</sup> ①	D <sub>1</sub>	L <sub>min.</sub>	a <sub>min.</sub>
M 2.5	0940 125 0005	0941 125 0005	5.0	5.0	0.6	4.1	6.0	3.8	6.2	6.0	1.5
M 3	0940 103 0005	0941 103 0005	5.5	5.0	0.6	4.7	6.0	4.4	6.2	6.5	1.8
	0940 103 0010	0941 103 0010	5.5	10.0	0.6	4.7	6.0	4.4	6.2	6.5	1.8
M 3.5	0940 135 0005	0941 135 0005	6.0	5.0	0.8	5.5	7.0	5.2	7.2	7.0	1.8
	0940 135 0010	0941 135 0010	6.0	10.0	0.8	5.5	7.0	5.2	7.2	7.0	1.8
M 4	0940 104 0005	0941 104 0005	7.5	5.0	0.8	5.9	8.0	5.8	8.2	8.5	2.0
	0940 104 0010	0941 104 0010	7.5	10.0	0.8	5.9	8.0	5.8	8.2	8.5	2.0
M 5	0940 105 0010	0941 105 0010	9.0	10.0	1.0	7.0	8.5	6.9	8.7	10.0	2.0
	0940 105 0015	0941 105 0015	9.0	15.0	1.0	7.0	8.5	6.9	8.7	10.0	2.0
M 6	0940 106 0010	0941 106 0010	10.0	10.0	1.0	8.6	10.0	8.5	10.2	11.0	2.5
	0940 106 0015	0941 106 0015	10.0	15.0	1.0	8.6	10.0	8.5	10.2	11.0	2.5

Metric ISO thread according to DIN 13-6g. Technical changes reserved. All measures in mm.

① Guideline values: depend on the moulding material, may have to be changed after installation tests.

② For blind holes we recommend to use core pins with ventilation bars. Feel free to request our company standard.

③ The flange has a large contact surface and thus reduces the surface pressure.



Above-mentioned items on request.

Other lengths, sizes, materials and special designs also on request.

# The variants – thread inserts for thermal installation, **HITSERT® Screwlock**

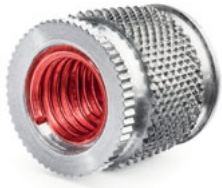

## Your advantages

- High pull-out values
- Ideal for thermoplastic parts
- Reduced weight
- HELICOIL® Screwlock allows up to 15 screwing cycles
- Complies with many aeronautical standards:
  - Locking torques as per NASM 8846
  - Test load values as per NASM 25027
- ...

## The principle

The HITSERT® Screwlock combines the advantages of the aluminium HITSERT® 2 and the stainless steel HELICOIL® Screwlock (as per NASM 21209). This combination offers you essential advantages for screw joints with high requirements.

The screw is locked by the polygonal shaped threads of the HELICOIL® Screwlock. These threads have a locking effect on the flanks of the screw or bolt to be screwed in. As a result, there is a high resilient frictional locking so that the screw is locked to prevent self-unscrewing.

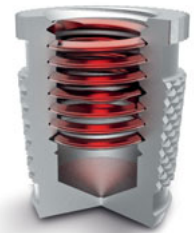

## Technical data

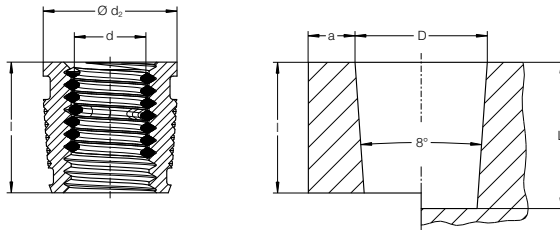

For installation tools and machines, please see pages 21–23

d	Item code	l	d <sub>2</sub>	D <sup>+0.1</sup>	L <sub>min.</sub>	a <sub>min.</sub>	m (g)
4-40 UNC	0934 565 6053	5.3	5.89	5.8	6.3	1.5	0.3
6-32 UNC	0934 567 6065	6.5	7.00	6.9	7.5	2.0	0.5
8-32 UNC	0934 568 6075	7.5	7.00	6.9	7.5	2.0	0.6
10-32 UNF	0934 569 7084	8.4	8.60	8.5	9.4	2.5	1.0
¼-28 UNF	0934 574 7109	10.9	11.00	10.9	11.9	2.5	2.0

d	Item code	l	d <sub>2</sub>	D <sup>+0.1</sup>	L <sub>min.</sub>	a <sub>min.</sub>	m (g)
M 2*	0934 502 0035	3.5	4.9	4.8	4.5	1.5	0.1
M 3	0934 503 0053	5.3	5.9	5.8	6.3	1.5	0.3
M 4	0934 504 0075	7.5	8.6	8.5	8.5	2.5	0.9
M 5	0934 505 0084	8.4	8.6	8.5	9.4	2.5	0.9
M 6	0934 506 0010	10.0	10.5	10.4	11.0	2.5	1.4

\*As per MA3329/190.

On request, HITSERT® Screwlock thread inserts are available with a blind-hole thread.  
Other sizes, special designs and materials on request.



**Your advantages**

- Well-proven 8° taper angle
- Self-centring
- Large contact surface for the plastic
- Flexible: thermal installation, tapping insertion or cold insertion
- Short installation times
- Milled external contour (low tolerances)
- Special designs with sealing rings realisable

**The principle**

The HITsert® 3 is a conical universal thread insert for thermoplastics (thermal installation, tapping insertion, cold insertion).

With its special external contour (characterised by a fine, self-tapping thread with asymmetric flank profile), the HITsert® 3 is a thread insert which can be used for the complete range of well-established installation methods.

Our Application Engineering Department helps you to find the perfect installation method for your application (in terms of installation effort and interference fit values).



**Technical data**

Material: **brass CuZn38Pb2** (compliant with EU 2000/53) / **brass CuZn39Pb3**

**Type 0935**

**Mounting hole**

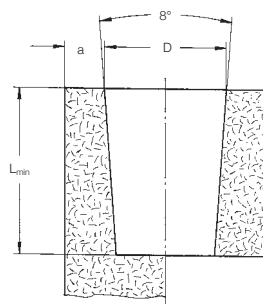
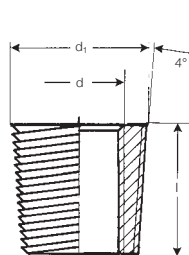

For installation tools and machines, please see pages 21–23

d	Item code	d <sub>1</sub>	l	D <sup>+0.1*</sup>	L <sub>min.</sub>	a <sub>min.</sub>
M 3	0935 103 0005	4.7	5.0	4.4	6.0	1.8
M 4	0935 104 0075	6.1	7.5	5.8	8.5	2.0
M 5	0935 105 0009	7.3	9.0	6.9	10.0	2.0
M 6	0935 106 0010	8.9	10.0	8.5	11.0	2.5

\*Guideline values: depend on the moulding material, may have to be changed after installation tests. Minimum quantity on request. All measures in mm. German and international patents have been applied for and granted.

## Technical data

### Torque values for HITSERT® M 3 to M 8 tested in different materials

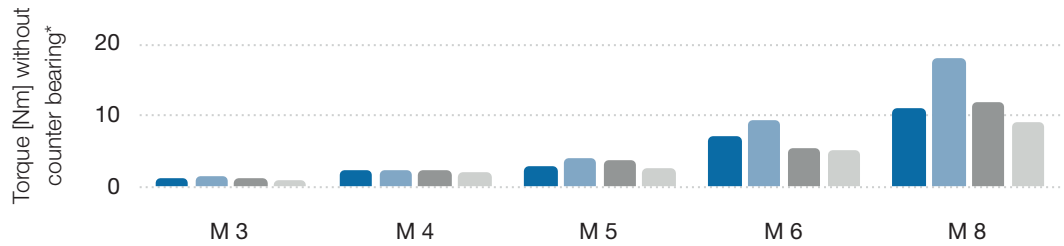

\*Guideline values from laboratory tests where the joint is subjected to overstress.

		M 3	M 4	M 5	M 6	M 8
■ ABS	MA [Nm]	1.20	2.25	2.90	7.00	11.00
■ PC	MA [Nm]	1.60	2.20	4.10	9.50	18.00
■ PA	MA [Nm]	1.05	2.40	3.75	5.50	12.00
■ PE/PP	MA [Nm]	1.00	2.10	2.50	5.00	9.00

All measures in mm.

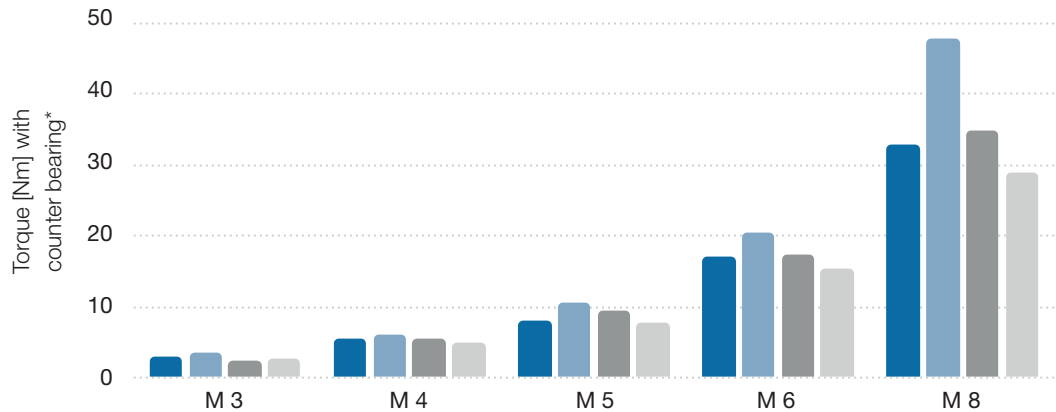

\*Guideline values from laboratory tests where the joint is subjected to overstress.

		M 3	M 4	M 5	M 6	M 8
■ ABS	MR [Nm]	3.00	5.50	8.00	17.00	33.00
■ PC	MR [Nm]	3.50	6.10	10.50	20.50	48.00
■ PA	MR [Nm]	2.50	5.60	9.50	17.50	35.00
■ PE/PP	MR [Nm]	2.70	5.00	7.80	15.50	29.00

All measures in mm.

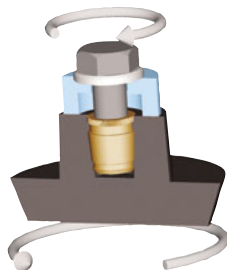

Torque without counter bearing (MA[Nm])\*\*

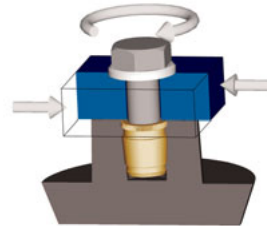

Torque with counter bearing (MR[Nm])\*\*  
Through hole as per DIN EN 20273 (medium)

\*\*In the MA test, comparative values can be determined. The test is not recommended for real screw joints.

\*\*\*The values for MR are usually limited by the screw fracture. For the design with counter bearing, tightening torques for property class 8.8 as per VDI 2230 can be applied.

## Technical data

### Pull-out values for **HITSERT® M 3 to M 8**

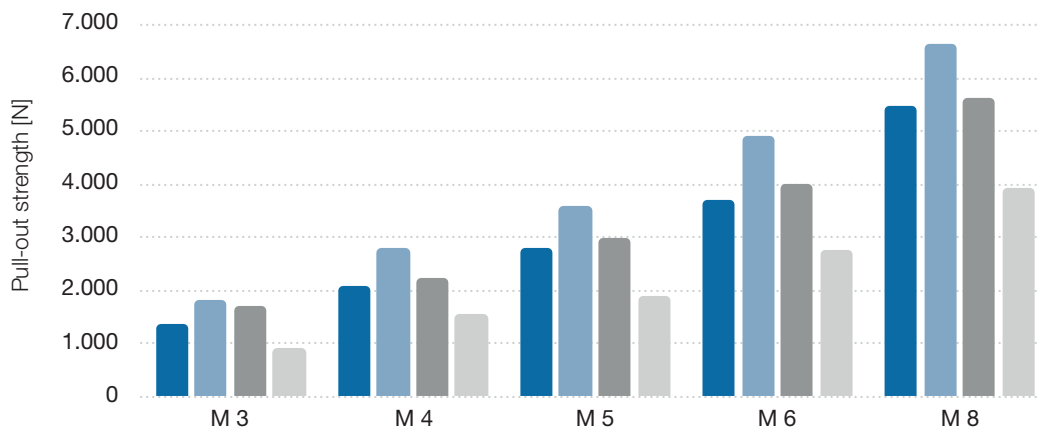

		M 3	M 4	M 5	M 6	M 8
■ ABS	FA [N]	1.350	2.100	2.800	3.700	5.500
■ PC	FA [N]	1.800	2.800	3.600	4.900	6.650
■ PA	FA [N]	1.700	2.250	3.000	4.000	5.650
■ PE/PP	FA [N]	900	1.550	1.900	2.750	3.950

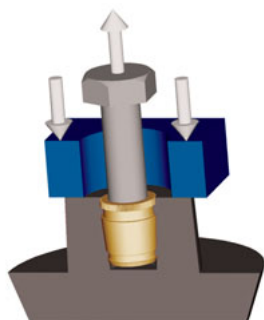

Pull-out strength (FA[N])

## Technical information

The specified values are guideline values. An application-specific installation test is recommended.

To be on the safe side, for fibre-reinforced plastics, the strengths of the non-reinforced material are to be assumed.

When using brass thread inserts in plastics susceptible to stress cracks (e.g. polycarbonate), we recommend an additional surface treatment for the thread inserts (nickel plating or surface coating as required).

You need strength values for other thread inserts? Please do not hesitate to contact us. We are happy to help.

# The variants – thread inserts for ultrasonic installation **SONICSERT®**



## Your advantages

- Suited for thermoplastic components
- Especially designed for ultrasonic installation
- Screw-locked and low-stress anchoring
- High pull-out values
- Type 0730 can be installed from both sides. Advantages for automatic feed since no directional orientation is required.

## The principle

The SONICSERT® thread insert can be embedded using common ultrasonic welders. During welding, the plastic material plasticises in the welding area due to the ultrasonic vibrations and flows into the undercuts of the thread insert. During cooling, a low-stress interference fit is achieved.

Thermal installation or inductive insertion are preferable.



## Technical data

Material: **brass CuZn38Pb2** (compliant with EU 2000/53) / **brass CuZn39Pb3** (steel 1.0718 11SMnPb30 as an option; surface to be agreed)

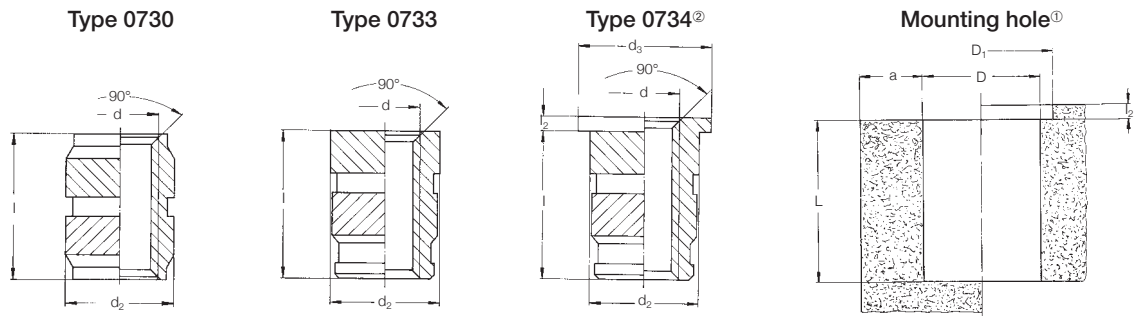

For installation tools and machines, please see pages 21–23

d	Type 0730 item code	Type 0733 item code	Type 0734 <sup>②</sup> item code	l	l <sub>2</sub>	d <sub>2</sub>	d <sub>3</sub> <sup>②</sup>	D <sup>+0.1①</sup>	D <sub>1</sub>	L <sub>min.</sub>	a <sub>min.</sub>
M 1.2 <sup>③</sup>	–	–	0734 112 0290	2.9	0.4	2.0	2.6	1.6	2.8	3.3	0.65
M 1.4 <sup>③</sup>	0730 114 0002	–	–	2.0	–	2.2	–	1.9	–	2.5	0.70
	–	–	0734 114 0310	3.1	0.4	2.2	2.8	1.8	3.0	3.5	0.70
M 1.6 <sup>③</sup>	0730 116 0250	–	–	2.5	–	3.0	–	2.6	–	3.0	0.80
	–	–	0734 116 0330	3.3	0.4	2.5	2.9	2.1	3.1	3.7	0.80
M 2	0730 102 0004	0733 102 0004	0734 102 0046	4.0	0.6	3.6	5.0	3.2	5.2	4.5	2.00
M 2.5	0730 125 0058	0733 125 0058	0734 125 0064	5.8	0.6	4.6	6.0	4.0	6.2	6.5	2.30
M 3	0730 103 0058	0733 103 0058	0734 103 0064	5.8	0.6	4.6	6.0	4.0	6.2	6.5	2.30
M 3.5	0730 135 0072	0733 135 0072	0734 135 0008	7.2	0.8	5.4	7.0	4.8	7.2	8.0	2.50
M 4	–	0733 104 0072	–	7.2	–	6.3	–	5.6	8.2	8.0	2.50
	0730 104 0082	0733 104 0082	0734 104 0009	8.2	0.8	6.3	8.0	5.6	8.2	9.0	2.50
M 5	–	0733 105 0082	–	8.2	–	7.0	–	6.4	8.7	9.0	2.70
	0730 105 0095	0733 105 0095	0734 105 0105	9.5	1.0	7.0	8.5	6.4	8.7	10.5	2.70
M 6	–	0733 106 0095	–	9.5	–	8.6	–	8.0	10.2	10.5	3.00
	0730 106 0127	0733 106 0127	0734 106 0137	12.7	1.0	8.6	10.0	8.0	10.2	14.0	3.00
M 8	0730 108 0127	0733 108 0127	0734 108 0137	12.7	1.0	10.2	12.0	9.6	12.2	14.0	3.50

Metric ISO thread according to DIN 13-6H. Technical changes reserved. All measures in mm.

<sup>①</sup> Guideline values: depend on the moulding material, may have to be changed after installation tests.

<sup>②</sup> The flange has a large contact surface and thus reduces the surface pressure. Minimum quantity on request.

<sup>③</sup> On request.

Other sizes, special designs and materials on request.



**Technical data**

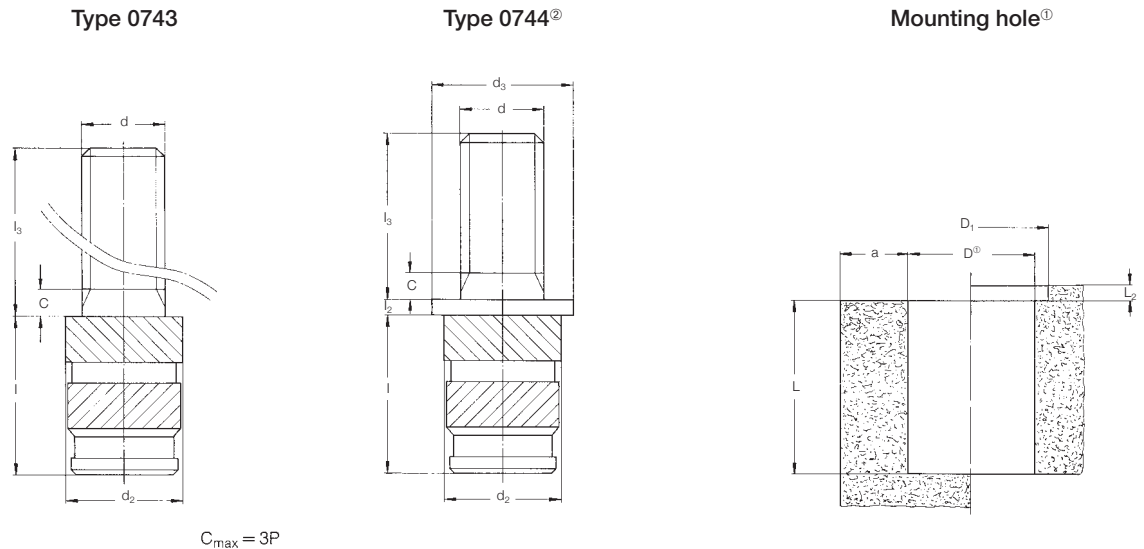

For installation tools and machines, please see pages 21–23

d	Type 0743 item code	Type 0744 <sup>Ⓜ</sup> item code	l	l <sub>2</sub> /L <sub>2</sub>	l <sub>3</sub>	d <sub>2</sub>	d <sub>3</sub> <sup>Ⓜ</sup>	D <sup>+0.1</sup> <sup>Ⓜ</sup>	D <sub>1</sub>	L <sub>min.</sub>	a <sub>min.</sub>
M 2	0743 102 0005	0744 102 0005	4.0	0.6	5.0	3.8	5.0	3.2	5.2	4.5	2.0
M 2.5	0743 125 0005	0744 125 0005	4.0	0.6	5.0	4.6	5.0	3.2	5.2	4.5	2.0
M 3	0743 103 0005	0744 103 0005	5.8	0.6	5.0	4.6	6.0	4.0	6.2	6.5	2.3
	0743 103 0010	0744 103 0010	5.8	0.6	10.0	4.6	6.0	4.0	6.2	6.5	2.3
M 3.5	0743 135 0005	0744 135 0005	7.2	0.8	5.0	5.4	7.0	4.8	7.2	8.0	2.5
	0743 135 0010	0744 135 0010	7.2	0.8	10.0	5.4	7.0	4.8	7.2	8.0	2.5
M 4	0743 104 0005	0744 104 0005	8.2	0.8	5.0	6.3	8.0	5.6	8.2	9.0	2.5
	0743 104 0010	0744 104 0010	8.2	0.8	10.0	6.3	8.0	5.6	8.2	9.0	2.5
M 5	0743 105 0010	0744 105 0010	9.5	1.0	10.0	7.0	8.5	6.4	8.7	10.5	2.7
	0743 105 0015	0744 105 0015	9.5	1.0	15.0	7.0	8.5	6.4	8.7	10.5	2.7
M 6	0743 106 0010	0744 106 0010	12.7	1.0	10.0	8.6	10.0	8.0	10.2	14.0	3.0
	0743 106 0015	0744 106 0015	12.7	1.0	15.0	8.6	10.0	8.0	10.2	14.0	3.0
M 8	0743 108 0010	0744 108 0010	12.7	1.0	10.0	10.0	12.0	9.6	12.2	14.0	3.5
	0743 108 0015	0744 108 0015	12.7	1.0	15.0	10.0	12.0	9.6	12.2	14.0	3.5

Metric ISO thread according to DIN 13-6g. Technical changes reserved. All measures in mm.

<sup>Ⓜ</sup> Guideline values: depend on the moulding material, may have to be changed after installation tests.

<sup>Ⓜ</sup> The flange has a large contact surface and thus reduces the surface pressure.



Above-mentioned items on request.

Other lengths, sizes, materials and special designs also on request.

**Torque values for SONICSERT® M 3 to M 8 tested in different materials**

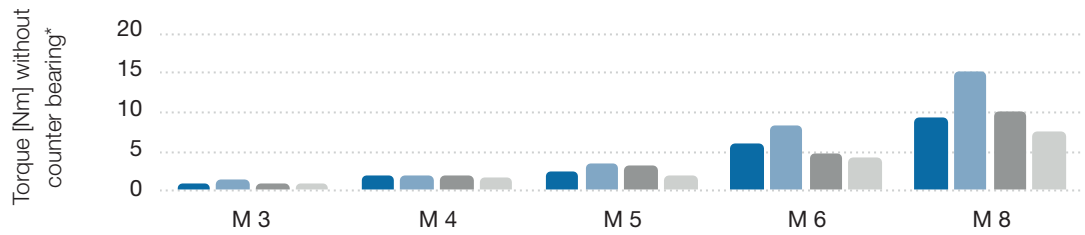

\*Guideline values from laboratory tests where the joint is subjected to overstress.

		M 3	M 4	M 5	M 6	M 8
■ ABS	MA [Nm]	1.00	1.90	2.50	6.00	9.40
■ PC	MA [Nm]	1.40	1.90	3.50	8.40	15.30
■ PA	MA [Nm]	0.90	2.00	3.20	4.70	10.20
■ PE/PP	MA [Nm]	0.90	1.80	2.10	4.30	7.70

All measures in mm.

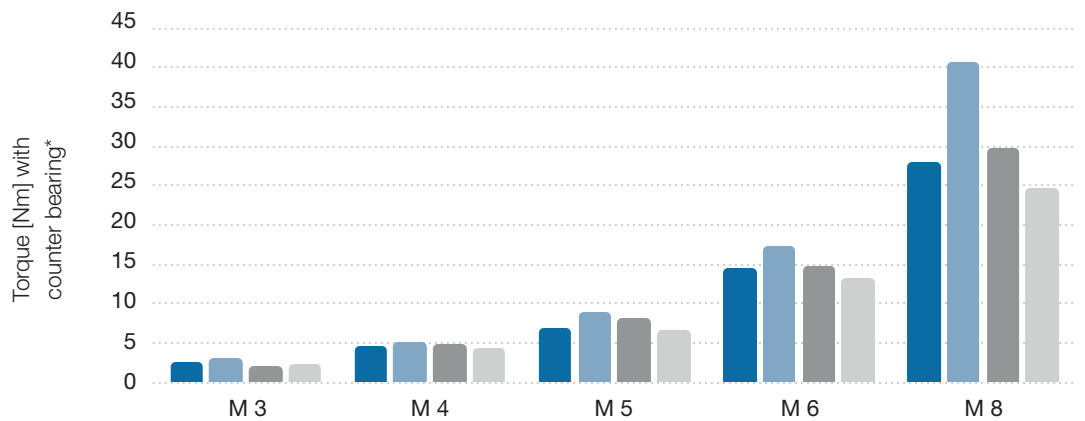

\*Guideline values from laboratory tests where the joint is subjected to overstress.

		M 3	M 4	M 5	M 6	M 8
■ ABS	MR [Nm]	2.60	4.70	6.80	14.50	28.10
■ PC	MR [Nm]	3.00	5.20	8.90	17.40	40.80
■ PA	MR [Nm]	2.10	4.80	8.10	14.90	29.80
■ PE/PP	MR [Nm]	2.30	4.30	6.60	13.20	24.70

All measures in mm.

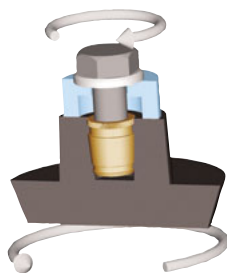

Torque without counter bearing (MA[Nm])\*\*

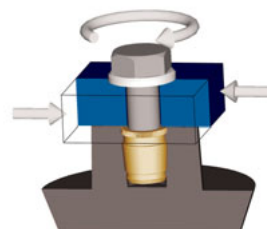

Torque with counter bearing (MR[Nm])\*\*  
Through hole as per DIN EN 20273 (medium)

\*\*In the MA test, comparative values can be determined. The test is not recommended for real screw joints.

\*\*\*The values for MR are usually limited by the screw fracture. For the design with counter bearing, tightening torques for property class 8.8 as per VDI 2230 can be applied.

## Technical data

### Pull-out values for **SONICSERT® M 3 to M 8** tested in different materials

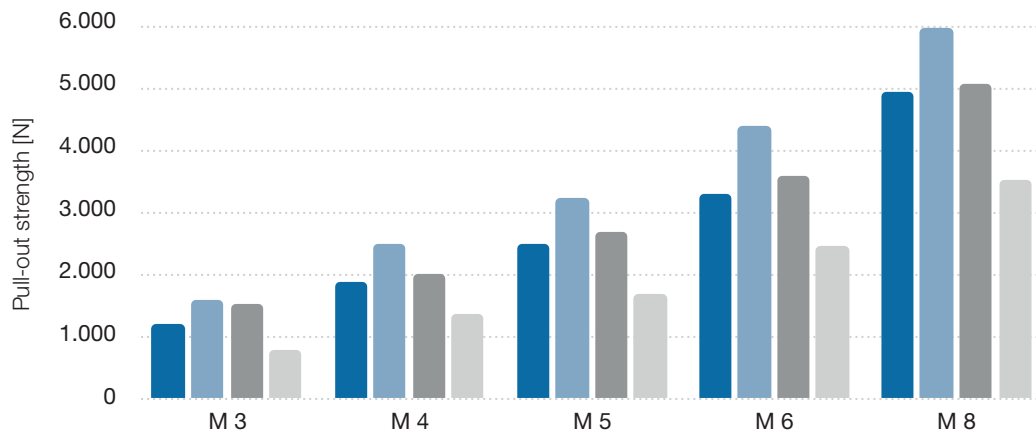

		M 3	M 4	M 5	M 6	M 8
■ ABS	FA [N]	1.215	1.890	2.520	3.330	4.950
■ PC	FA [N]	1.620	2.520	3.240	4.410	5.985
■ PA	FA [N]	1.530	2.025	2.700	3.600	5.085
■ PE/PP	FA [N]	810	1.395	1.710	2.475	3.555

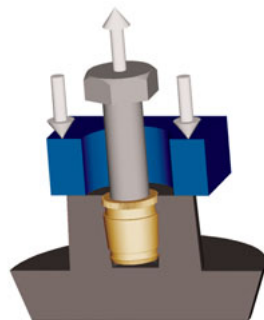

Pull-out strength (FA[N])

## Technical information

The specified values are guideline values. An application-specific installation test is recommended.

To be on the safe side, for fibre-reinforced plastics, the strengths of the non-reinforced material are to be assumed.

When using brass thread inserts in plastics susceptible to stress cracks (e.g. polycarbonate), we recommend an additional surface treatment for the thread inserts (nickel plating or surface coating as required).

You need strength values for other thread inserts? Please do not hesitate to contact us. We are happy to help.



## Electromagnetic resistance welding – ERW

ERW is a joining method developed by KVT Bielefeld GmbH (Germany) for metal–thermoplastic joints. An electromagnetic AC field heats the thread insert without contact and the contact surface of the plastic component plasticises. In the simultaneous joining process, the fused material is displaced into recesses and undercuts.

Metal elements of any size are heated within a very short time (approx. 2–6 sec.). After switching off the power supply, the accelerated cooling of the melt allows to achieve an installation accuracy of up to 0.05 mm.



## Heated element welding – HEW

HEW is an approved joining method to embed metal thread inserts in thermoplastic components. It is a single-phase process in which contact heat is transferred through the metal insert to the joining zone of the plastic material.

The joining process is realised while the plastic material is fused in the area of the contact surface. In that process, the plasticised mass is displaced into defined recesses and undercuts to achieve positive locking.



## Ultrasonic welding – USW

USW is a process which had originally been developed to join thermoplastic components. Within a very short time, the plastic material is plasticised through boundary-layer friction and vibration absorption of the parts to be joined.

After that, joining is executed. The required energy is generated from alternating voltage in the ultrasonic generator, converted into mechanical vibration (20–40 kHz) and then introduced into the thread insert with a sonotrode.

When thread inserts (M 2–M 6) are embedded in thermoplastics, the fused material is displaced into recesses and undercuts.



Which installation method is most suited for your application?  
Please do not hesitate to contact us.

Thermal installation machines for **AMTEC®** thread inserts



ERW thermal installation machine for embedding HITCERT® thread inserts in parts of car engine compartments



ERW thermal installation machine for embedding four HITCERT® thread inserts in a boot handle



ERW thermal installation machine for embedding eight M 1.6 HITCERT® thread inserts in two mobile phone case halves



KVT 02 lever thermal installation machine for embedding HITCERT<sup>®</sup> thread inserts for small series production

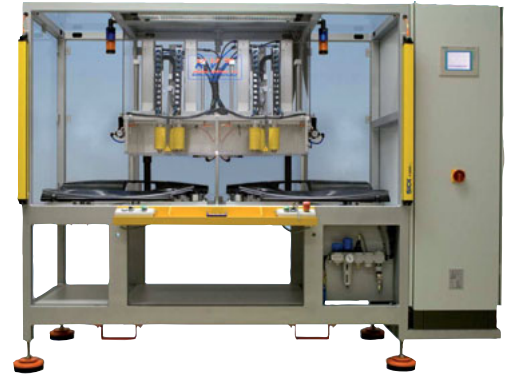

Special thermal installation machine for the simultaneous embedding of six HITCERT<sup>®</sup> thread inserts in two car door trims



KVT Basic 5000 DUO thermal installation machine for the simultaneous thermal installation of four HITCERT<sup>®</sup> thread inserts in two car wing mirror covers



KVT Basic 2500 thermal installation machine for the simultaneous thermal installation of two HITCERT<sup>®</sup> thread inserts in a car charge air pipe



KVT Bielefeld GmbH, a company of the Dukane Corporation, Rabenhof 18 a, 33609 Bielefeld Germany, phone: +49(0)521/932070, e-mail: [info@kvt-bielefeld.de](mailto:info@kvt-bielefeld.de)

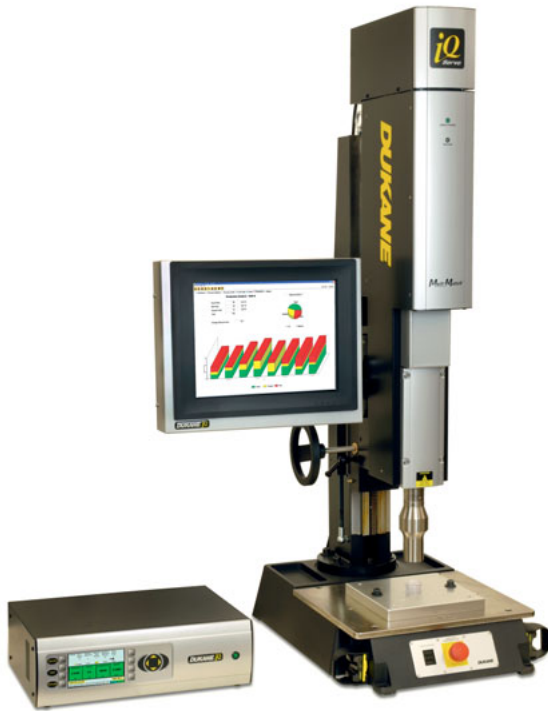

Ultrasonic welding machine with a working frequency of 20 kHz for ultrasonic riveting or welding or embedding UNITEC® K' in K' inserts.  
All process parameters and their transfer to superordinate systems for production data acquisition can be monitored.



Ultrasonic welding machine with a working frequency of 35 kHz for ultrasonic riveting or welding

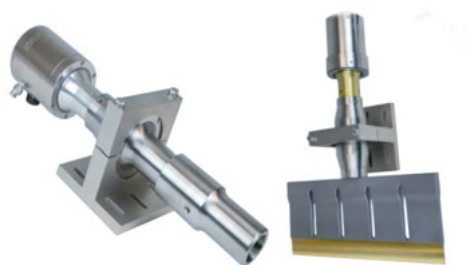

Sonotrode for the integration into standard and special systems



Digital/analog ultrasonic generator for the integration into standard and special systems





	Page
AMTEC® High-strength thread inserts for plastic components	5
The advantages – an overview	5
Selection matrix for AMTEC® thread inserts	6
Selection matrix for installation methods	7

## Variants

### Thread inserts for thermal installation

HITSERT® 2	10
HITSERT® Screwlock	12
HITSERT® 3	13
HITSERT®	14
SONICSERT®	16
Installation methods	20
Installation machines	21

### Thread inserts for self-tapping insertion

QUICKSERT®	26
QUICKSERT® Hex	30
QUICKSERT® Plus	31
Installation tools	33

### Thread inserts for expansion anchoring

EXPANSIONSERT 1	38
EXPANSIONSERT 2	40
SPREDSERT® 1	41
SPREDSERT® 2	42
SPREDSERT® 1 and 2 technical data	43
SPREDSERT® with retaining flange	45
QUICKSERT® type 1230	46
Installation tools	48
Potential and realised applications	50

# The variants – thread inserts for self-tapping insertion **QUICKSERT®**



## Your advantages

- Universal use
- High-strength and torsion-resistant threads
- For brittle and ductile plastics such as unsaturated polyester resins (SMC, ZMC), polyurethane and glass-fibre reinforced thermoplastics
- Optimum installation characteristics

## The principle

The QUICKSERT® consists of a cylindrical basic body with internal thread and a special external thread. The profile of the external thread has an extremely small flank angle and expands asymmetrically toward the thread root. With the special geometry of the flank angles, the radial tension is minimised. The installation with low driving torques is therefore optimised. A high interference fit is achieved with an ideal distribution of load. The bottom part of the thread insert is provided with a cutting slot. For special requirements, we offer a version with flange. The QUICKSERT® is screwed in with a rotating spindle.



## Technical data

Material: **brass CuZn38Pb2** (compliant with EU 2000/53) / **brass CuZn39Pb3** or steel 1.0718 11SMnPb30 galvanised, chromated

Type 1434

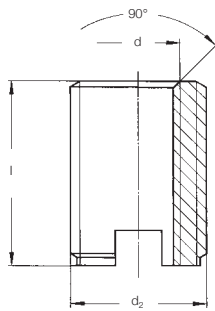

Mounting hole<sup>①</sup>

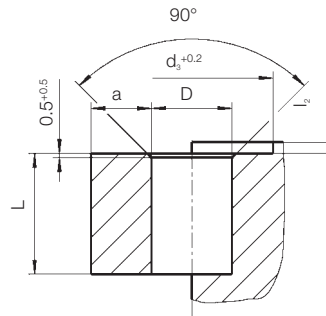

For installation tools and machines, please see pages 33–35

d	Steel, unhardened item code	Brass item code	l	d <sub>2</sub>	D* <sup>①</sup>	L <sub>min.</sub>	a <sub>min.</sub>
M 3	1434 103 0006	1434 503 0006	6.0	6.0	4.6–5.4	7.0	2.0
M 4	1434 104 0008	1434 504 0008	8.0	7.0	5.6–6.6	9.0	3.0
M 5	1434 105 0010	1434 505 0010	10.0	8.0	6.6–7.6	11.0	4.0
M 6	1434 106 0014	1434 506 0014	14.0	10.0	8.1–9.4	15.0	4.0
M 8	1434 108 0015	1434 508 0015	15.0	12.0	10.1–11.4	16.0	5.0
M 10 <sup>②</sup>	1434 110 0018	1434 510 0018	18.0	14.0	12.1–13.4	19.0	5.0

Metric ISO thread according to DIN 13-6H. Technical changes reserved. All measures in mm.

<sup>①</sup> Guideline values: depend on the moulding material, may have to be changed after installation tests.

<sup>②</sup> Minimum quantity on request.

\*See table on page 21.

Other sizes and special designs on request.

**Technical data**

**Type 1433<sup>®</sup>**

**Mounting hole**

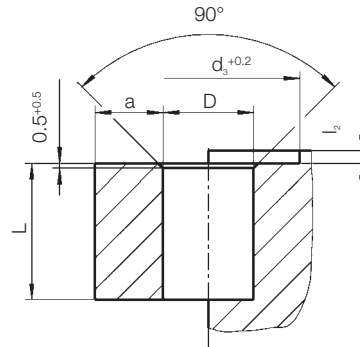
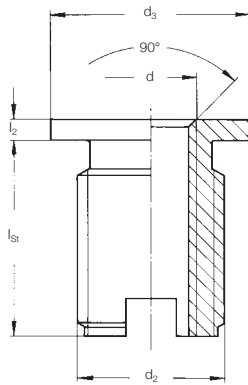

The flange version has a large contact surface and thus reduces the surface pressure.

**Recommended mounting holes – diameter in mm – for QUICKSERT<sup>®</sup> in different materials<sup>®</sup>**

	M 3	M 4	M 5	M 6	M 8	M 10
PE (soft), PP	4.6	5.6	6.6	8.1	10.1	12.1
PA 6, PA 6.6, PBT, PE (hard), PET, POM	4.8	5.8	6.8	8.3	10.3	12.3
ASA, SAN	5.0	6.0	7.0	8.5	10.5	12.5
ABS, PA 6 GF 30 %, PBT GF 30 %, PET GF 30 %, PS, PVC (hard)	5.2	6.2	7.2	8.7	10.7	12.7
PA 6.6 GF 30 %, PC, PC GF 30 %, PPE (GF 30 %), PPS (GF 30 %)	5.4	6.4	7.4	9.0	11.0	13.0
SMC, ZMC, BMT		6.6	7.6	9.4	11.4	13.4

Version with hexagon flange on request.

**For installation tools and machines, please see pages 33–35**

d	Steel, unhardened	Brass item code	$l_{St}$	$l_{Ms}$	$l_2$	$d_2$	$d_3$	$D^{*①}$	$L_{min, St}$	$L_{min, Ms}$	$a_{min}$
M 4	1433 104 0105	1433 504 0009	9.5	8.0	1.0	7.0	10.0	5.6–6.6	10.5	9.0	3.0
M 5	1433 105 0127	1433 505 0112	11.5	10.0	1.2	8.0	11.0	6.6–7.6	12.5	11.0	4.0
M 6	1433 106 0174	1433 506 0154	16.0	14.0	1.4	10.0	13.0	8.1–9.4	17.0	15.0	4.0
M 8	1433 108 0184	1433 508 0164	17.0	15.0	1.4	12.0	15.0	10.1–11.4	18.0	16.0	5.0

Metric ISO thread according to DIN 13-6H. Technical changes reserved. All measures in mm.

① Guideline values: depend on the moulding material, may have to be changed after installation tests.

② Hardened version on request.

\* See table above.

Other sizes and special designs on request.

Minimum quantity on request.

## Technical data

### Torque values for QUICKSERT® M 3 to M 8 tested in different materials

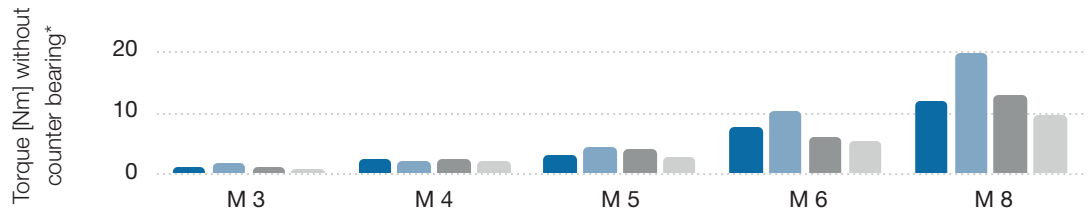

\*Guideline values from laboratory tests where the joint is subjected to overstress.

		M 3	M 4	M 5	M 6	M 8
■ ABS	MA [Nm]	1.3	2.5	3.2	7.7	12.1
■ PC	MA [Nm]	1.8	2.4	4.5	10.5	19.8
■ PA	MA [Nm]	1.2	2.6	4.1	6.1	13.2
■ PE/PP	MA [Nm]	1.1	2.3	2.8	5.5	9.9

All measures in mm.

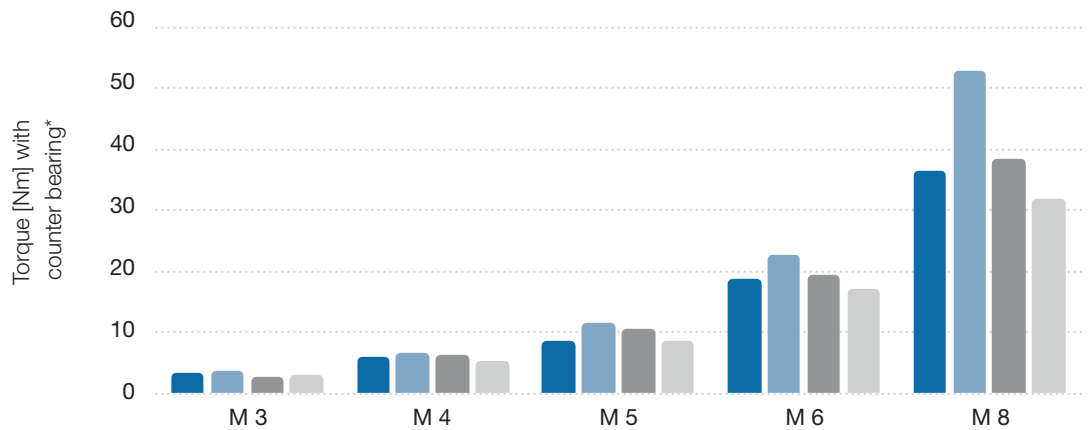

\*Guideline values from laboratory tests where the joint is subjected to overstress.

		M 3	M 4	M 5	M 6	M 8
■ ABS	MR [Nm]	3.3	6.1	8.8	18.7	36.3
■ PC	MR [Nm]	3.9	6.7	11.6	22.6	52.8
■ PA	MR [Nm]	2.8	6.2	10.5	19.3	38.5
■ PE/PP	MR [Nm]	3.0	5.5	8.6	17.1	31.9

All measures in mm.

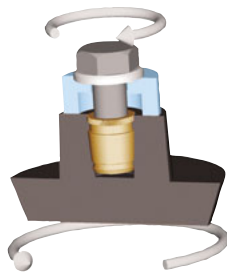

Torque without counter bearing (MA[Nm])\*\*

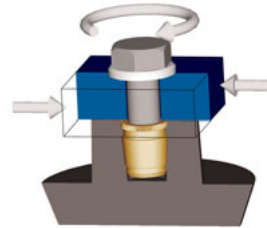

Torque with counter bearing (MR[Nm])\*\*  
Through hole as per DIN EN 20273 (medium)

\*\*In the MA test, comparative values can be determined. The test is not recommended for real screw joints.

\*\*\*The values for MR are usually limited by the screw fracture. For the design with counter bearing, tightening torques for property class 8.8 as per VDI 2230 can be applied.

## Technical data

### Pull-out values for QUICKSERT® M 3 to M 8 tested in different materials

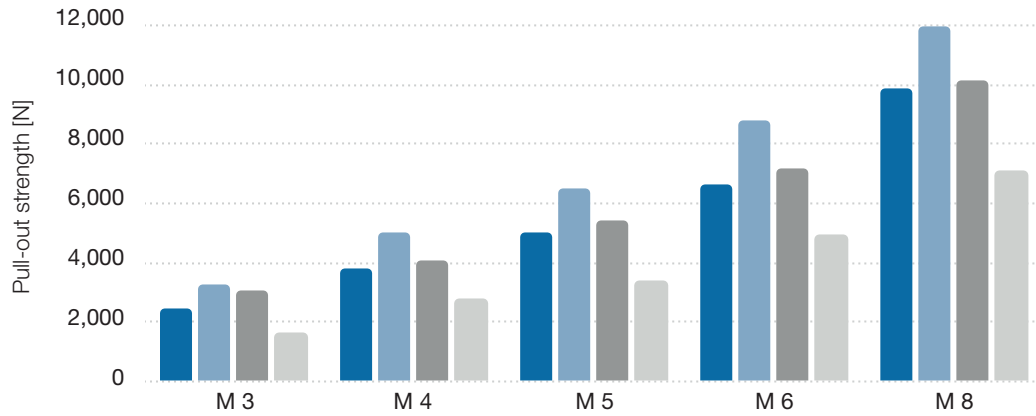

		M 3	M 4	M 5	M 6	M 8
■ ABS	FA [N]	2,430	3,780	5,040	6,660	9,900
■ PC	FA [N]	3,240	5,040	6,480	8,820	11,970
■ PA	FA [N]	3,060	4,050	5,400	7,200	10,170
■ PE/PP	FA [N]	1,620	2,790	3,420	4,950	7,110

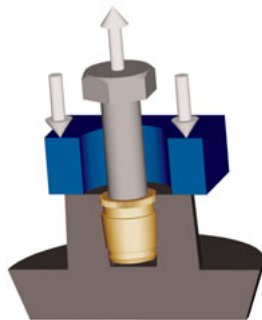

Pull-out strength (FA[N])

## Technical information

The specified values are guideline values. We recommend an application-specific installation test. To be on the safe side, for fibre-reinforced plastics, the strengths of the non-reinforced material are to be assumed. Strength values for other thread inserts on request.

# The variants – thread inserts for self-tapping insertion **QUICKSERT® Hex**



## Your advantages

- Process-reliable and efficient installation with additional driver shape – hexagon socket
- For thermoplastics and thermosets
- Extra small flank angles of the special external thread minimise radial tensions
- High-strength and torsion-resistant threads
- Special version available with external left-hand thread for improved reverse locking

## The principle

The QUICKSERT® Hex consists of a cylindrical basic body with an internal thread and a shaped hexagon as well as a special external thread.

The profile of the external thread has an extremely small flank angle and expands asymmetrically toward the thread root. The installation with low driving torques is therefore optimised. A high interference fit is achieved with an ideal distribution of load. The bottom part of the bush is provided with a cutting slot. For special requirements, we offer a version with flange. The threaded bush is plugged on and screwed in with a rotating spindle. It is not necessary to screw out the spindle.

## Technical data

Material: **brass CuZn38Pb2** (compliant with EU 2000/53) / **brass CuZn39Pb3** or steel 1.0718 11SMnPb30 galvanised, chromated.

Type 1437

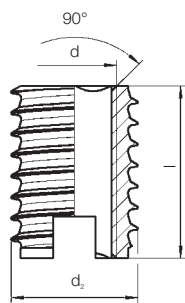

Type 1438

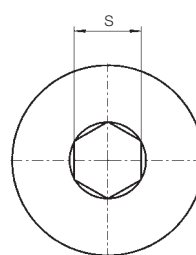
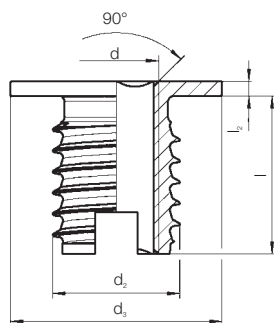

Mounting hole

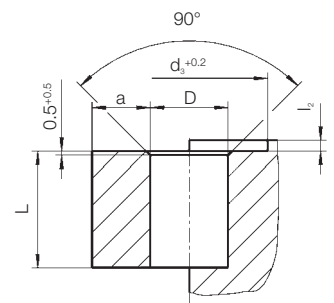

The flange version has a large contact surface and thus reduces the surface pressure.

For installation tools and machines, please see pages 33–35

d	Brass, standard item code	Brass, flange item code	l	l <sub>2</sub>	d <sub>2</sub>	d <sub>3</sub>	L <sub>min.</sub>	a <sub>min.</sub>	S
M 4	1437 504 0008	1438 504 0009	8.0	1.0	7.0	10.0	9.0	3.0	3.2
M 5	1437 505 0010	1438 505 0112	10.0	1.2	8.0	11.0	11.0	4.0	4.0
M 6	1437 506 0014	1438 506 0154	14.0	1.4	10.0	13.0	15.0	4.0	5.0
M 8	1437 508 0016	1438 508 0164	15.0	1.4	12.0	15.0	16.0	5.0	6.5

Minimum quantity on request.  
All measures in mm. Metric ISO thread according to DIN 13-6H.  
Technical changes reserved.

## Recommended mounting holes – diameter in mm – for QUICKSERT® in different materials

	M 4	M 5	M 6	M 8
PE (soft), PP	5.6	6.6	8.1	10.1
PA 6, PA 6.6, PBT, PE (hard), PET, POM	5.8	6.8	8.3	10.3
ASA, SAN	6.0	7.0	8.5	10.5
ABS, PA 6 GF 30 %, PBT GF 30 %, PET GF 30 %, PS, PVC (hard)	6.2	7.2	8.7	10.7
PA 6.6 GF 30 %, PC, PC GF 30 %, PPE (GF 30 %), PPS (GF 30 %)	6.4	7.4	9.0	11.0
SMC, ZMC, BMT	6.6	7.6	9.4	11.4

# The variants – thread inserts for self-forming insertion **QUICKSERT® Plus**



## Your advantages

- Suited for thermoplastic components
- High-strength and torsion-resistant threads
- Chipless installation
- Special version available with external left-hand thread for improved reverse locking

## The principle

The QUICKSERT® Plus consists of a conical basic body (8° overall taper) with internal thread, shaped hexagon and a special external thread.

The profile of the external thread has an extremely small flank angle and expands asymmetrically toward the thread root. The driving torques for the installation are thus reduced. A high interference fit is achieved with an ideal distribution of load. Since no cutting slot is required, there are no chips because the thread insert forms into the plastic.

For special requirements, we offer a version with flange.

The flange version has a large contact surface and thus reduces the surface pressure.

The threaded bush is plugged on and screwed in with a rotating spindle.

## Technical data

Material: **brass CuZn38Pb2** (compliant with EU 2000/53) / **brass CuZn39Pb3** or steel 1.0718 11SMnPb30 galvanised, chromated.

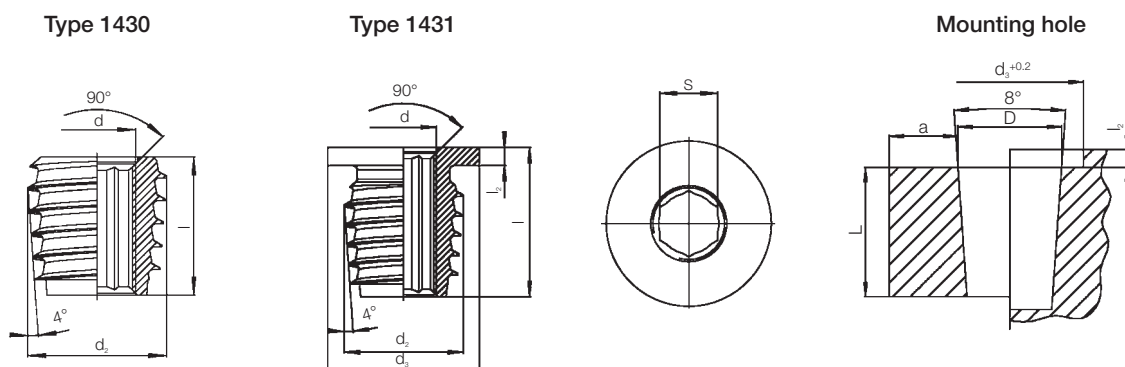

For installation tools and machines, please see pages 33–35

d	Brass item code	D <sup>+0.1</sup> ①	l	d <sub>2</sub>	L <sub>min.</sub> ②	a <sub>min.</sub> ①	S
M 4	1430 004 0008	7.10	8.00	7.74	8.00	5.00	3.20
M 5	1430 005 0009	8.20	9.00	9.15	9.00	5.50	4.00
M 6	1430 006 0011	9.50	11.00	10.70	11.00	6.00	5.00
M 8	1430 008 0014	11.90	14.00	13.69	14.00	7.00	6.50

d	Brass, with flange item code	D <sup>+0.1</sup> ①	l	l <sub>2</sub>	d <sub>2</sub>	d <sub>3</sub>	L <sub>min.</sub> ②	a <sub>min.</sub> ①	S
M 4	1431 004 0104	7.20	10.40	1.4	7.68	10.00	9.00	5.00	3.20
M 5	1431 005 0114	8.30	11.40	1.4	9.12	11.50	10.40	5.50	4.00
M 6	1431 006 0134	9.60	13.40	1.4	10.67	13.00	12.00	6.00	5.00
M 8	1431 008 0174	12.20	17.40	1.4	13.76	18.00	16.00	7.00	6.50

① Guideline value – depends on the moulding material, may have to be changed after installation tests.

② For blind hole L + 1 mm.

All measures in mm.

### Technical data

**Driving torque values for QUICKSERT® Plus M 5 tested in different materials**

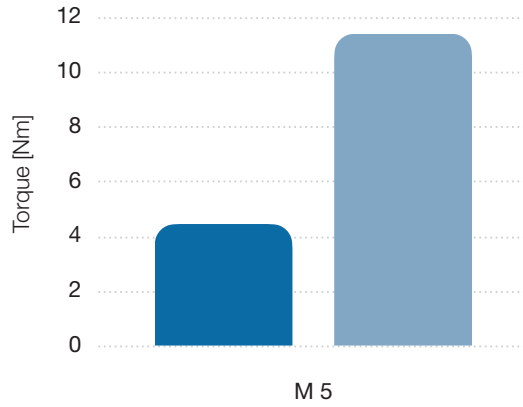

	ME [Nm]	M 5
PP		4.5
PA 6 GF 30		11.4

**Pull-out values for QUICKSERT® Plus M 5 tested in different materials**

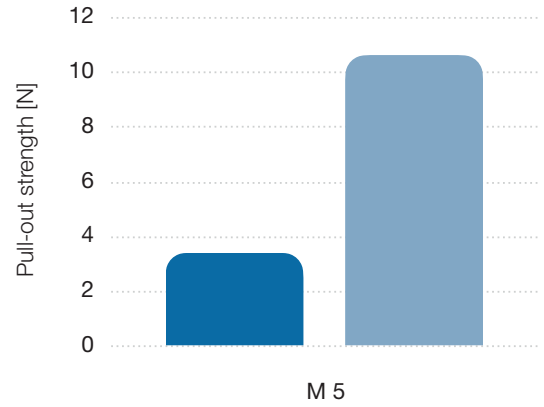

	FA [N]	M 5
PP		3.417
PA 6 GF		10.631

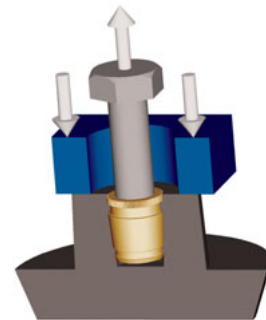

Pull-out strength (FA[N])

### Technical information

The specified values are guideline values. We recommend an application-specific installation test. With the special geometry of the flank angles, the radial tension is minimised. To be on the safe side, for fibre-reinforced plastics, the strengths of the non-reinforced material are to be assumed. Strength values for other thread inserts on request.



**Installation tools**

**QUICKSERT® self-tapping insertion**

Installation tool with impact mechanism to safely screw out of the installed QUICKSERT®.

To be used on box-column drilling machines and adaptable (drive A/F 9) for the use with cordless screwdrivers with pneumatic or electrical switchover or reversal of the direction of rotation.

d	QUICKSERT® manual installation item code
M 3	1450 010 3000
M 4	1450 010 4000
M 5	1450 010 5000
M 6	1450 010 6000
M 8	1450 010 8000
M 10	1450 011 0000



**Semi-automatic installation**

**QUICKSERT® self-tapping insertion**

**pneumatic screwdriver**

- High power due to automatic reverse when reaching the set torque
- Stationary operation due to adaptation to parallel guide
- Medium to large series

d	Overall device <sup>①</sup> item code	Exchange unit <sup>②</sup> item code
M 3	1460 030 3000	1460 030 3050
M 4	1460 030 4000	1460 030 4050
M 5	1460 030 5000	1460 030 5050
M 6	1460 030 6000	1460 030 6050
M 8	1460 030 8000	1460 030 8050
M 10	1460 031 0000	1460 031 0050

Matching parallel guide 0182 060 0010

① Overall device



② Exchange unit



Please observe the driving torque according to the table on page 32.

**Parallel system type S**

Type	Product characteristics		Item code
S 600	work radius	140 mm – 600 mm	0182 080 0003
	work height	50 mm – 430 mm	
	weight without tool	8 kg	
	torque absorption	15 Nm max.	

Type	Size	Item code
Service unit	at 6 bar nominal flow G 1/4" = 700 l/min	
Hose	LW 6	0196 000 1130
Hose clip	8 – 12 mm	0196 000 1150
Hose tail	G 1/8"-6	0196 000 1151
Hose tail	G 1/4"-6	0196 000 1152
Exhaust air hose	Ø 15 mm	0196 000 1131

**Delivery scope:**

- 3-axis guiding system
- Tool holder
- 1 balancer 1–3 kg
- Base plate made of extruded aluminium profile with grooves, dimensions w x h x l: 240 x 40 x 500 mm



**Your advantages**

- Rationalisation
- Quick and safe positioning
- No operator fatigue
- No return rotation forces
- Absorption of the screwdriver weight
- Easy handling
- Flexibility
- Can be used with electrical or pneumatic installation tools
- Quick retooling
- 360° rotatable
- Smooth and precise roller guides
- Optimum workstation layout

# Installation tools **QUICKSERT® Hex and Plus**

## Installation mandrel

The installation mandrel for the QUICKSERT® Plus and Hex has a 1/4" hex drive according to DIN 3126 E 6.3/DIN ISO 1173. Mounting with slide and spring clip.

### Your advantages:

- For fast snap-on of the QUICKSERT® with hexagon socket
- Fast pull-out after installation, spinning off not required

The installation mandrel is suited for small and medium series. It can be adapted for the use with a cordless screwdriver or a type P-S 1216 pneumatic installation tool.

### QUICKSERT® Hex self-tapping insertion and QUICKSERT® Plus

d	Item code
M 4	1467 020 5040
M 5	1467 020 5050
M 6	1467 020 5060
M 8	1467 020 5080



## Installation tools

### Type P-S 1216

For the fast processing of **QUICKSERT® Hex and QUICKSERT® Plus**  
 Plastic stop ring to conserve the component surfaces

### Technical data:

Idle speed:	950 min <sup>-1</sup> at p = 6.3 bar adjustable through air pressure
Air consumption:	5.5 L/s at p = 6.3 bar
Torque:	M = 1.2 – 5.5 Nm continuously adjustable shut-off clutch
Tool holder:	1/4" hexagon with radial bearing
Weight:	0.8 kg
Item code:	<b>4160 180 0010</b>

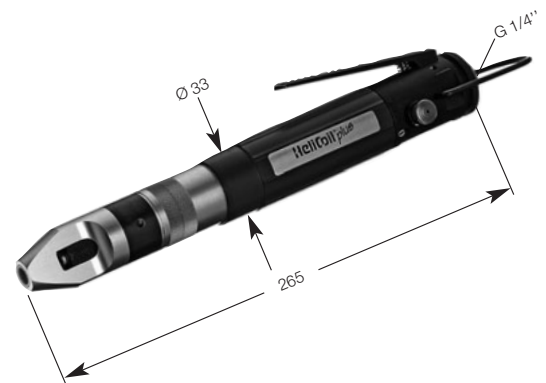

### E-PSG 256 Quick Exchange – quick change of different sizes without loss of performance

With these electrical installation tools, Böllhoff sets new standards for demanding industries. Interested?  
 Please do not hesitate to contact us.



We will be happy to also offer you automated processing.  
 Do not hesitate to contact us.

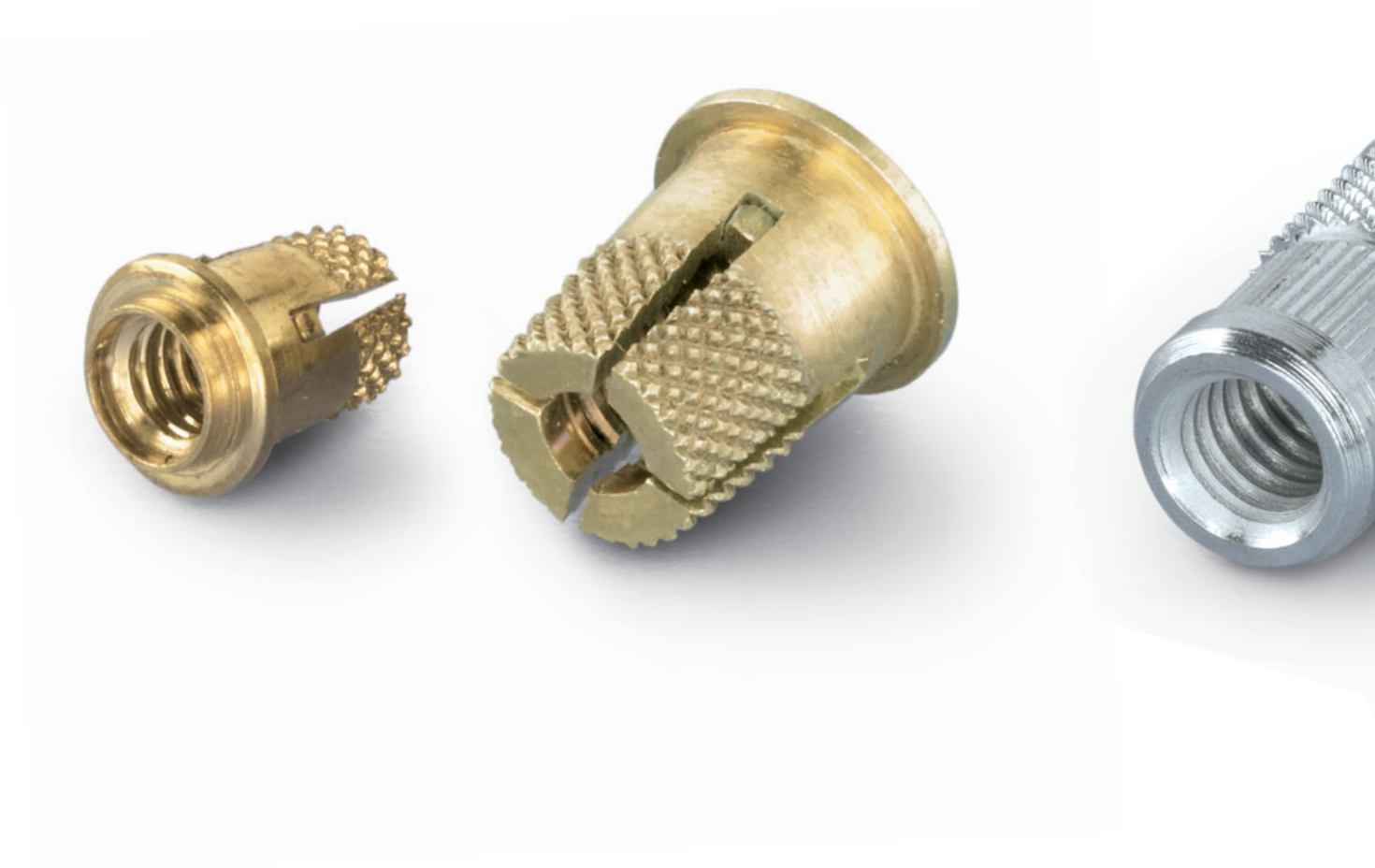

	Page
AMTEC® High-strength thread inserts for plastic components	5
The advantages – an overview	5
Selection matrix for AMTEC® thread inserts	6
Selection matrix for installation methods	7

## Variants

### Thread inserts for thermal installation

HITSERT® 2	10
HITSERT® Screwlock	12
HITSERT® 3	13
HITSERT®	14
SONICSERT®	16
Installation methods	20
Installation machines	21

### Thread inserts for self-tapping insertion

QUICKSERT®	26
QUICKSERT® Hex	30
QUICKSERT® Plus	31
Installation tools	33

### Thread inserts for expansion anchoring

EXPANSIONSERT 1	38
EXPANSIONSERT 2	40
SPREDSERT® 1	41
SPREDSERT® 2	42
SPREDSERT® 1 and 2 technical data	43
SPREDSERT® with retaining flange	45
QUICKSERT® type 1230	46
Installation tools	48
Potential and realised applications	50

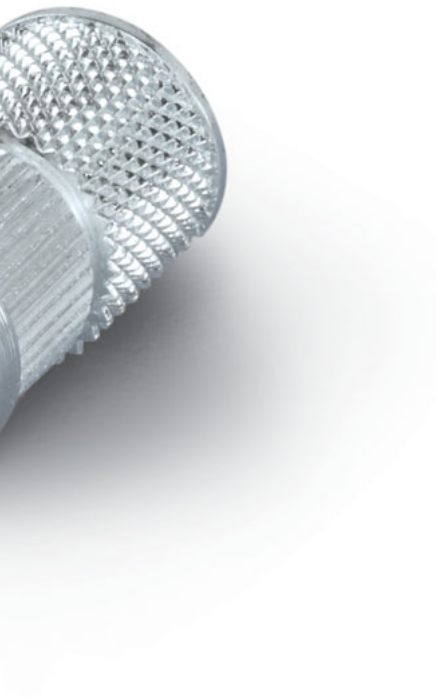

# The variants – thread inserts for expansion anchoring **EXPANSIONSERT 1**

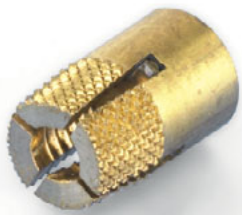

## Your advantages

- Universal thread insert for thermoset and thermoplastic components
- High-strength threads by expansion anchoring
- Quick, cost-effective installation

## The principle

The EXPANSIONSERT 1 thread insert consists of a cross-slotted basic body with an internal thread, which has an external diamond knurl, and an expanding plate. When the thread insert is installed in the mounting hole, the diamond knurl part is expanded by the expanding plate which is pressed down. As a result, it is anchored in the wall of the hole. The EXPANSIONSERT 1 had been especially developed for the use in blind holes.

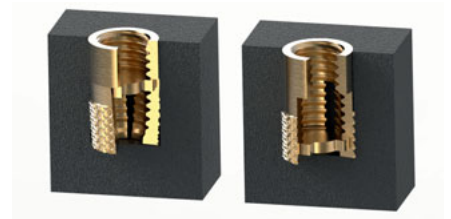

## Technical data

Material: **brass CuZn38Pb2** (compliant with EU 2000/53) / **brass CuZn39Pb3**.

Type 0230  
EXPANSIONSERT 1 Standard

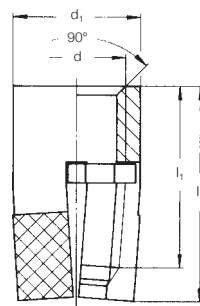

Mounting hole<sup>①</sup>

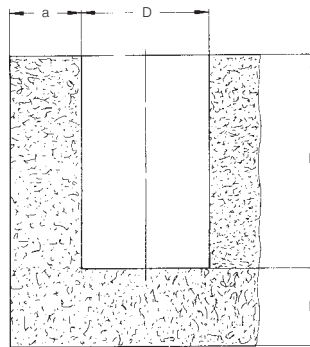

For installation tools and machines, please see pages 48–49

d	Item code	d <sub>1</sub>	l	l <sub>1 min.</sub>	D <sup>+0.1①</sup>	L	a <sub>min.</sub>	b <sub>min.</sub>
M 2.5	0230 025 0065	4.0	6.5	4.0	4.0	6.5	2.4	3.2
M 3	0230 903 0001	4.0	6.5	4.0	4.0	6.5	2.4	3.2
	0230 003 0065	4.8	6.5	4.0	4.8	6.5	2.9	3.2
M 3.5	0230 035 0008	4.8	8.0	5.0	4.8	8.0	2.9	4.0
M 4	0230 004 0095	5.5	9.5	6.5	5.5	9.5	3.3	4.7
	0230 004 0008	5.5	8.0	5.0	5.5	8.0	3.3	4.0
M 5	0230 005 0011	6.5	11.0	7.5	6.5	11.0	3.9	5.5
	0230 005 0008	6.5	8.0	4.5	6.5	8.0	3.9	4.0
M 6	0230 006 0125	8.0	12.5	8.5	8.0	12.5	4.8	6.2
M 8	0230 008 0016	11.0	16.0	11.0	11.0	16.0	6.6	8.0

Metric ISO thread according to DIN 13-6H. Technical changes reserved. Minimum quantity on request. All measures in mm.

<sup>①</sup> Guideline values: depend on the moulding material, may have to be changed after installation tests.

Other sizes and special designs on request.

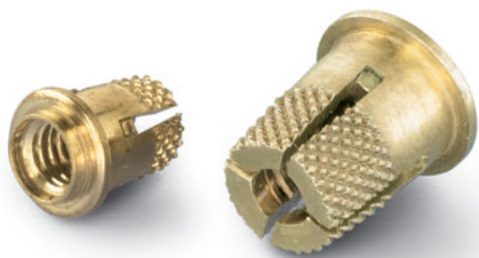

**Type 0231<sup>Ⓢ</sup>**  
**EXPANSIONINSERT 1 flange**

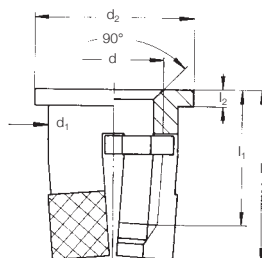

**Mounting hole<sup>Ⓢ</sup>**

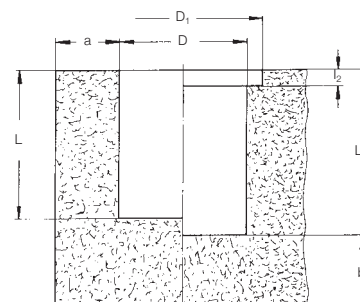

**Technical data**

For installation tools, see page 48

d	Item code	l	d <sub>1</sub>	d <sub>2</sub>	l <sub>1 min.</sub>	l <sub>2</sub>	D <sup>+0.1Ⓢ</sup>	D <sub>1</sub> <sup>+0.2</sup>	L	L <sub>1</sub>	a <sub>min.</sub>	b <sub>min.</sub>
M 2.5	0231 025 0006	6.0	4.0	5.5	3.6	0.8	4.0	5.5	5.2	6.0	2.4	3.2
M 3	0231 003 0006	6.0	4.8	6.3	3.5	0.8	4.8	6.3	5.2	6.0	2.9	3.2
M 3.5	0231 035 0075	7.5	4.8	6.3	4.7	0.8	4.8	6.3	6.7	7.5	2.9	4.0
M 4	0231 004 0075	7.5	5.5	7.0	4.4	0.8	5.5	7.0	6.7	7.5	3.3	4.7
M 5	0231 005 0085	8.5	6.5	8.0	5.0	0.8	6.5	8.0	7.7	8.5	3.9	5.5
M 6	0231 006 0011	11.0	8.0	10.0	7.0	0.8	8.0	10.0	10.2	11.0	4.8	6.2

Metric ISO thread according to DIN 13-6H. Delivery conditions according to DIN 267. Technical changes reserved. Minimum quantity on request.

<sup>Ⓢ</sup> Guideline values: depend on the moulding material, may have to be changed after installation tests.

The flange has a large contact surface and thus reduces the surface pressure.

Other sizes and special designs on request.

**Type 0232**  
**EXPANSIONINSERT 1 Clinch**

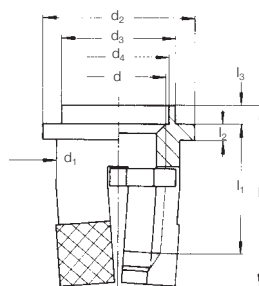

**Mounting hole<sup>Ⓢ</sup>**  
(dimensions as type 0231)

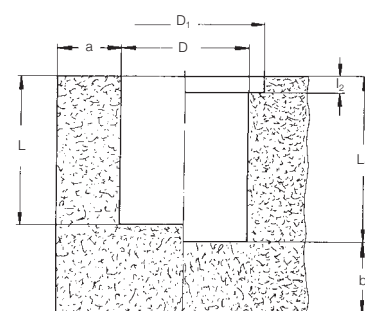

The flanged edge is designed to fasten contact components and cable eyes as well as to serve as a fixing aid for a cover part to be applied.

For installation tools see page 48

d	Item code	l	d <sub>1</sub>	d <sub>2</sub>	d <sub>3 max.</sub>	d <sub>4</sub>	D <sup>+0.1Ⓢ</sup>	D <sub>1</sub> <sup>+0.2</sup>	l <sub>1 min.</sub>	l <sub>2</sub>	l <sub>3</sub>
M 2.5	0232 025 0007	7.0	4.0	5.5	3.6	2.8	4.0	5.5	3.6	0.8	1.0
M 3	0232 003 0007	7.0	4.8	6.3	4.1	3.3	4.8	6.3	3.5	0.8	1.0
M 3.5	0232 035 0085	8.5	4.8	6.3	4.6	3.8	4.8	6.3	4.7	0.8	1.0
M 4	0232 004 0085	8.5	5.5	7.0	5.1	4.3	5.5	7.0	4.4	0.8	1.0
M 5	0232 005 0095	9.5	6.5	8.0	6.1	5.3	6.5	8.0	5.0	0.8	1.0
M 6	0232 006 0012	12.0	8.0	10.0	7.1	6.3	8.0	10.0	7.0	0.8	1.0

Metric ISO thread according to DIN 13-6H. Technical changes reserved. Minimum quantity on request. All measures in mm.

<sup>Ⓢ</sup> Guideline values: depend on the moulding material, may have to be changed after installation tests.

Other sizes and special designs on request.

# The variants – thread inserts for expansion anchoring **EXPANSIONSERT 2**



## Your advantages

- For reactive resins, PUR, elastomers, integral hard foams as well as for wood composite materials
- Wear-resistant threads
- Quick, cost-effective installation

## The principle

The EXPANSIONSERT 2 thread insert consists of a body with an internal thread, which has knurls and undercuts on the circumferential surface. Inside the body, there is an expanding plate that is pressed down when the thread insert is installed in the mounting hole. Upon installation, the slotted bottom part of the EXPANSIONSERT 2 is expanded and its cutting rings are anchored in the wall of the mounting hole. The thread insert is thus reliably locked against pull-out and screwing.

The EXPANSIONSERT 2 had been especially developed for the use in blind holes.



## Technical data

Material: steel 1.0718 11 SMnPb 30 galvanised, chromated or **brass CuZn38Pb2** (compliant with EU 2000/53) / **brass CuZn39Pb3**.

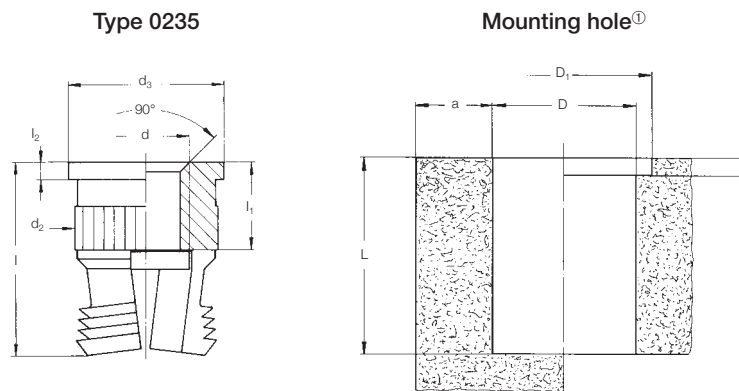

For installation tools and machines, please see pages 48–49

d	Item code	l	d <sub>2</sub>	d <sub>3</sub>	l <sub>1</sub>	l <sub>2</sub>	D <sup>+0.10</sup>	D <sub>1</sub>	L <sub>min.</sub>	a <sub>min.</sub>
M 3	0235 103 0008	8.0	5.9	7.0	3.0	0.8	5.5	7.2	8.2	4.0
M 3.5	0235 135 0008	8.0	5.9	7.0	3.5	0.8	5.5	7.2	8.2	4.0
M 4	0235 104 0095	9.5	6.9	8.0	4.0	0.8	6.5	8.2	9.8	5.0
M 5	0235 105 0011	11.0	8.4	10.0	5.0	0.8	8.0	10.2	11.3	6.0
M 6	0235 106 0125	12.5	8.4	10.0	6.0	0.8	8.0	10.2	12.8	6.0

Metric ISO thread according to DIN 13-6H. Technical changes reserved. Minimum quantity on request. All measures in mm.

® Guideline values: depend on the moulding material, may have to be changed after installation tests.

Other sizes and special designs on request.



# The variants – thread inserts for expansion anchoring **SPREDSERT® 1**



## Your advantages

- For thermoplastic parts
- Fast installation without a special tool
- Retaining flange and anchor rings ensure a high degree of locking against screwing and tensile load
- Screw-locking

## The principle

The SPREDSERT® 1 is pressed flush into the mounting hole until the retaining flange has been completely anchored in the plastic material. In that process, the slotted area is compressed. The radially locked SPREDSERT® 1 is expanded by the screw so that the anchor rings penetrate the plastic material and ensure the interference fit of the thread insert.

In this process, the screw is also locked. For the additional expansion force, the tightening torque must be increased by 10 %.



## Technical data

Material: **brass CuZn38Pb2** (compliant with EU 2000/53) / **brass CuZn39Pb3**.

Type 0831 – 0833

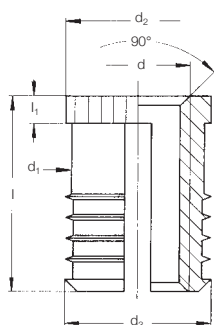

Mounting hole<sup>①</sup>

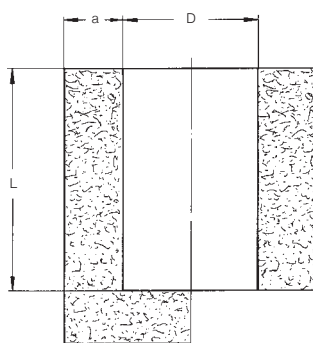

For installation tools and machines, please see pages 48–49

d	Item code	Number of anchor	d <sub>1</sub>	d <sub>2</sub>	d <sub>3</sub>	l <sup>②</sup>	l <sub>1</sub>	D <sup>+0,1①</sup>	L <sub>min.</sub>	a <sub>min.</sub>
M 2	0832 102 0004	3	3.15	3.70	3.6	4.0	0.60	3.2	4.5	2.0
M 2.5	0832 125 0005	3	3.90	4.50	4.4	5.0	0.75	4.0	5.5	2.5
M 3	0832 103 0005	3	3.90	4.50	4.4	5.0	0.75	4.0	5.5	3.0
M 3.5	0832 135 0065	3	4.70	5.30	5.2	6.5	1.00	4.8	7.1	3.2
M 4	0833 104 0008	4	5.35	6.00	5.9	8.0	1.30	5.5	8.7	3.5
M 5	0833 105 0095	5	6.35	7.00	6.9	9.5	1.30	6.5	10.3	4.0
M 6	0831 106 0011	5	7.85	8.50	8.4	11.0	2.00	8.0	12.0	5.0
M 8	0831 108 0013	5	9.50	9.95	9.9	13.0	2.00	9.6	14.0	7.0

Metric ISO thread according to DIN 13-6H. Technical changes reserved. Minimum quantity on request. All measures in mm.

<sup>①</sup> Guideline values: depend on the moulding material, may have to be changed after installation tests.

<sup>②</sup> Screw contact length = min. thread insert length (l) + 1p (pitch)

Other sizes and special designs on request.



## Your advantages

- For thermoset parts
- Fast installation without special tools
- Retaining flange and diamond knurl ensure a high degree of locking against screwing and tensile load
- Screw-locking

## The principle

The SPREDSERT® 2 is pressed flush into the mounting hole until the retaining flange has been completely anchored in the plastic material. In that process, the slotted area is compressed. The radially locked SPREDSERT® 2 is expanded by the screw so that the diamond knurl penetrates the plastic material and ensures the interference fit of the thread insert.

In this process, the screw is also locked. For the additional expansion force, the tightening torque must be increased by 10 %.



## Technical data

Material: **brass CuZn38Pb2** (compliant with EU 2000/53) / **brass CuZn39Pb3**.

Type 0837

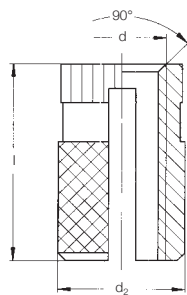

Mounting hole<sup>①</sup>

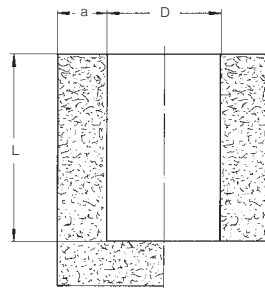

For installation tools and machines, please see pages 48–49

d	Item code <sup>②</sup>	l <sup>③</sup>	d <sub>2</sub>	D <sup>+0.1①</sup>	L <sub>min.</sub>	a <sub>min.</sub>
M 3	0837 103 0005	5.0	4.3	3.9	5.5	3.0
M 3.5	0837 135 0064	6.4	5.1	4.7	7.0	3.3
M 4	0837 104 0008	8.0	6.0	5.5	8.5	3.5
M 5	0837 105 0095	9.5	6.8	6.3	10.0	4.0
M 6	0837 106 0127	12.7	8.4	7.9	13.5	5.0

Metric ISO thread according to DIN 13-6H. Technical changes reserved. All measures in mm.

<sup>①</sup> Guideline values: depend on the moulding material, may have to be changed after installation tests.

<sup>②</sup> Minimum quantity on request.

<sup>③</sup> Screw contact length = min. thread insert length (l) + 1p (pitch)

Other sizes and special designs on request.

The variants – thread inserts for expansion anchoring **SPREDSERT® 1** and **2**

**Technical data**

**Torque values for SPREDSERT® 1 and 2 / M 3 to M 8 tested in different materials**

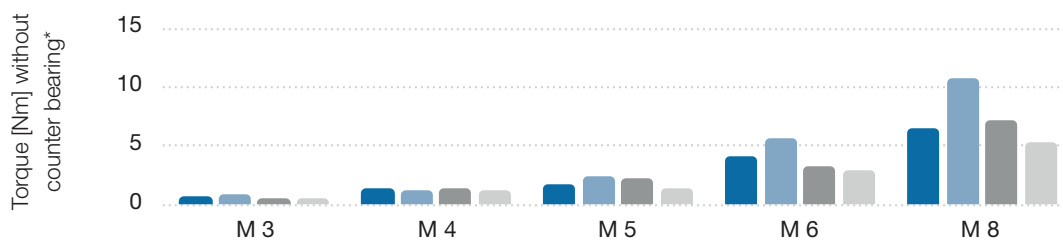

\*Guideline values from laboratory tests where the joint is subjected to overstress.

		M 3	M 4	M 5	M 6	M 8
■ ABS	MA [Nm]	0.72	1.35	1.74	4.20	6.60
■ PC	MA [Nm]	0.96	1.32	2.46	5.70	10.80
■ PA	MA [Nm]	0.63	1.44	2.25	3.30	7.20
■ PE/PP	MA [Nm]	0.60	1.26	1.50	3.00	5.40

All measures in mm.

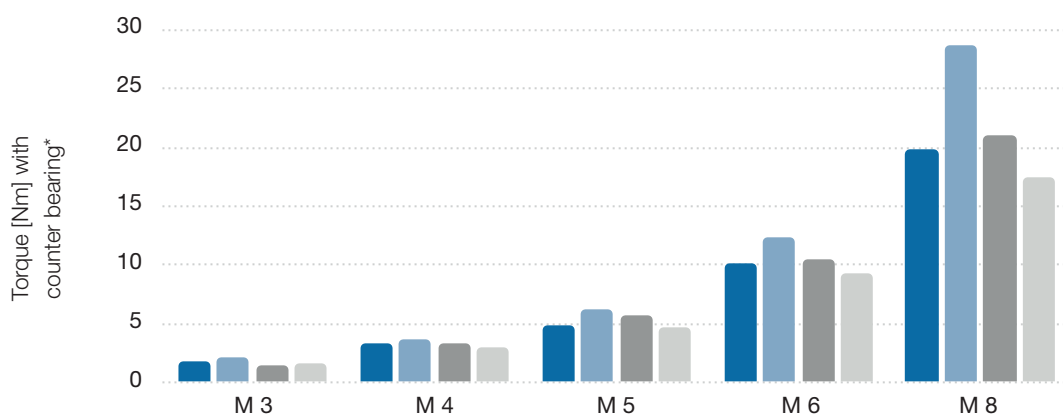

\*Guideline values from laboratory tests where the joint is subjected to overstress.

		M 3	M 4	M 5	M 6	M 8
■ ABS	MR [Nm]	1.80	3.30	4.80	10.20	19.80
■ PC	MR [Nm]	2.10	3.66	6.30	12.30	28.80
■ PA	MR [Nm]	1.50	3.36	5.70	10.50	21.00
■ PE/PP	MR [Nm]	1.62	3.00	4.68	9.30	17.40

All measures in mm.

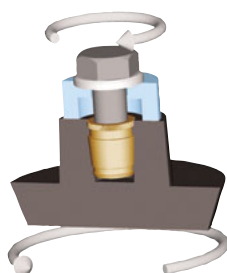

Torque without counter bearing (MA[Nm])\*\*

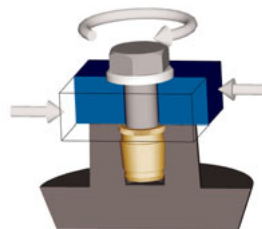

Torque with counter bearing (MR[Nm])\*\*  
Through hole as per DIN EN 20273 (medium)

\*\*In the MA test, comparative values can be determined. The test is not recommended for real screw joints.

\*\*\*The values for MR are usually limited by the screw fracture. For the design with counter bearing, tightening torques for property class 8.8 as per VDI 2230 can be applied.

### Technical data

#### Pull-out values for SPREDSERT® 1 and 2 / M 3 to M 8 tested in different materials

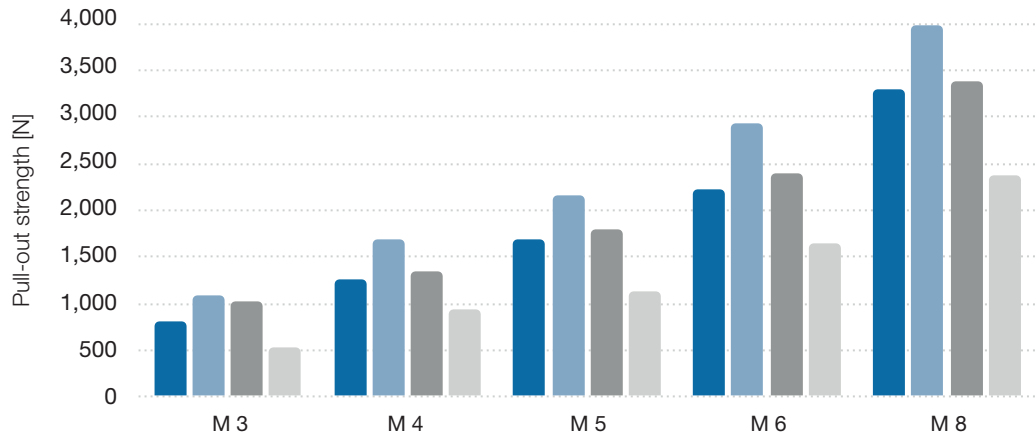

		M 3	M 4	M 5	M 6	M 8
■ ABS	FA [N]	810	1,260	1,680	2,220	3,300
■ PC	FA [N]	1,080	1,680	2,160	2,940	3,990
■ PA	FA [N]	1,020	1,350	1,800	2,400	3,390
■ PE/PP	FA [N]	540	930	1,140	1,650	2,370

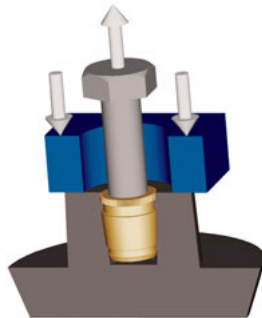

Pull-out strength (FA[N])

### Technical information

The specified values are guideline values. We recommend an application-specific installation test.

To be on the safe side, for fibre-reinforced plastics, the strengths of the non-reinforced material are to be assumed.

When using brass thread inserts in plastics susceptible to stress cracks (e.g. polycarbonate), we recommend an additional surface treatment for the thread inserts (nickel plating or surface coating as required).

Strength values for other thread inserts on request.

The variants – thread inserts for expansion anchoring **SPREDSERT®** with retaining flange



**Your advantages**

- For thermoset and thermoplastic components
- Fast installation without a special tool
- High-strength threads in through holes
- Screw-locking

**The principle**

The SPREDSERT® with retaining flange is pressed into the rear of the through hole (accessibility from two sides) until the retaining flange touches the component. The slotted anchoring section with diamond knurl is compressed. When the screw is screwed in, the thread insert is forced open in the anchoring section so that the diamond knurl penetrates the plastic material. The retaining flange which acts as a shoulder support ensures a good locking effect against pull-out due to additional positive locking. In addition, the screw is locked. For the additional expansion force, the tightening torque must be increased by 10 %.



**Technical data**

Material: **brass CuZn38Pb2** (compliant with EU 2000/53) / **brass CuZn39Pb3**.

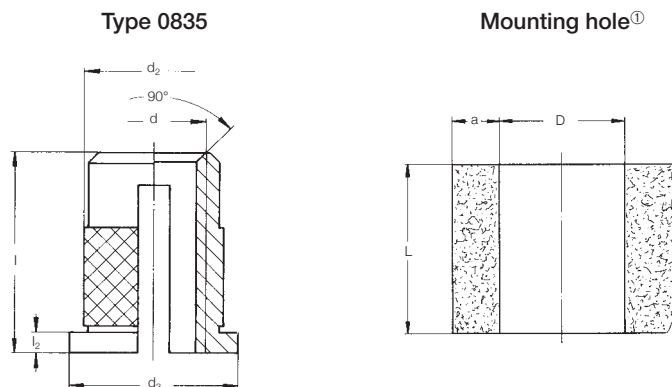

For installation tools and machines, please see pages 48–49

d	Item code	l <sup>③</sup>	d <sub>2</sub>	d <sub>3</sub>	l <sub>2</sub>	D <sup>+0.1①</sup>	L <sub>min</sub>	a <sub>min</sub>
M 3	0835 103 0048	4.8	4.3	5.5	0.5	3.9	4.5	3.2
M 3.5	0835 135 0064	6.4	5.1	6.3	0.7	4.7	6.0	3.6
M 4	0835 104 0008	8.0	6.0	7.0	0.8	5.5	7.5	4.0
M 5	0835 105 0095	9.5	6.8	8.0	1.0	6.3	9.0	4.8
M 6	0835 106 0127	12.7	8.4	9.5	1.3	7.9	12.0	6.0
M 8	0835 108 0127	12.7	9.9	11.0	1.3	9.4	12.0	7.1

Metric ISO thread according to DIN 13-6H. Technical changes reserved. Minimum quantity on request. All measures in mm.

① Guideline values: depend on the moulding material, may have to be changed after installation tests.

③ Screw contact length = min. thread insert length (l) + 1p (pitch)

Other sizes and special designs on request.

# The variants – thread inserts for expansion anchoring

## QUICKSERT® Expansion type 1230



### Your advantages

- No tapping
- Quick, cost-effective installation
- Chipless installation in smooth mounting holes
- High-strength threads also in light metals
- High-strength threads in thermoplastic and thermoset components\*\* after demoulding the components
- Suited for one-sided accessibility of the installation point
- For screw joints reusable as often as required
- For installation on finished surfaces

### The principle

The QUICKSERT® Expansion type 1230 is spun on to the rotating threaded mandrel of the installation tool and introduced into the mounting hole.

The hole can be preformed or machined with common drills as a blind or through hole. Through the axial pulling motion of the threaded mandrel in the installation tool, the QUICKSERT® Expansion shears at the predetermined breaking point between the anchoring sleeve and the threaded bush. The threaded bush is pulled into the anchoring sleeve and expands it. Meanwhile, the diamond knurl of the anchoring sleeve is pressed into the wall of the hole. The thread insert is now anchored and locked against screwing and pull-out.



### Technical data

Material: **brass CuZn38Pb2** (compliant with EU 2000/53) / **brass CuZn39Pb3** or steel 1.0718 11SMnPb30+c  
surface: A2J ISO 4042 Cr(VI)-free (aluminium materials on request)

Type 1230

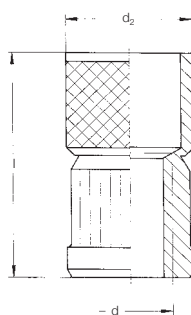

Mounting hole<sup>①</sup>

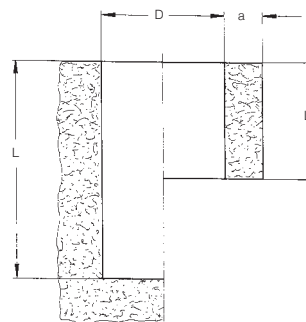

For installation tools and machines, please see pages 48–49

d	Steel item code	Brass item code	Total length l	Total length installed l <sub>1</sub>	Knurl ø d <sub>2</sub>	Mounting hole			
						D <sup>+0.1</sup> Ⓢ	L <sub>min</sub>	a <sub>2min</sub>	a
M 3	1230 003 0048	1230 103 0048	8.0	4.8	5.5	5.5	8.8	4.8	2.0
M 4	1230 004 0063	1230 104 0063	10.5	6.3	6.5	6.5	11.8	6.3	2.0
M 5	1230 005 0082	1230 105 0082	13.5	8.2	7.5	7.5	15.2	8.2	2.5
M 6	1230 006 0098	1230 106 0098	16.0	9.8	9.0	9.0	18.8	9.8	3.0
M 8	1230 008 0115	1230 108 0115	19.0	11.5	12.0	12.0	21.0	11.5	4.0

Minimum quantity on request. All measures in mm.

For the installation into plastics, we recommend brass thread inserts. Special lengths and thread diameters as well as other materials on request.

Ⓢ Guideline values: depend on the moulding material, may have to be changed after installation tests.

\*\* When this insert is to be used with plastics susceptible to stress cracks (e.g. PC, PPO), it must be particularly tested for suitability.

**Pull-out values for QUICKSERT® Expansion type 1230 / M 6 and M 8 tested in PA 6.6 GF**

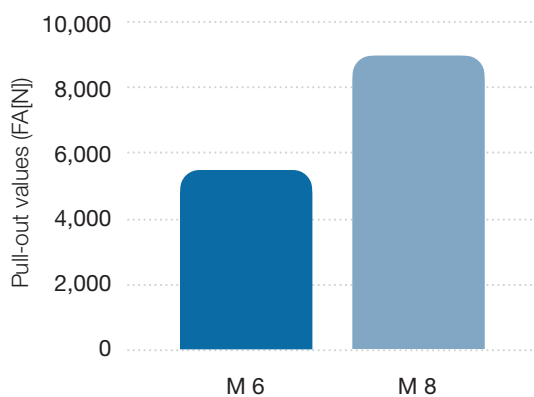

**Torque values for QUICKSERT® Expansion type 1230 / M 6 and M 8 tested in PA 6.6 GF**

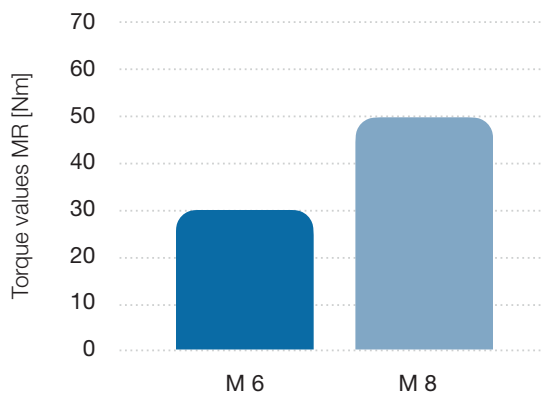

## Manual installation tools

### EXPANSIONSERT 1, EXPANSIONSERT 2, SPREDSERT® 1 and 2

Assembly mandrels for the manual installation of EXPANSIONSERT 1 and EXPANSIONSERT 2 thread inserts



	EXPANSIONSERT 1 Standard item code	EXPANSIONSERT 1 Flange/clinch item code	EXPANSIONSERT 2 item code	SPREDSERT® item code
M 2.5	0250 025 0065	0253 025 0006	–	0851 125 0000
M 3	0250 003 0065	0253 003 0006	0254 103 0008	0851 103 0000
M 3.5	0250 035 0008	0253 035 0075	–	0851 135 0000
M 4	0250 004 0095	0253 004 0075	0254 104 0095	0851 104 0000
	0250 004 0008	–	–	–
M 5	0250 005 0011	0253 005 0085	0254 105 0011	0851 105 0000
	0250 005 0008	–	–	–
M 6	0250 006 0125	0253 006 0011	0254 106 0125	0851 106 0000
M 8	0250 008 0016	–	–	0851 108 0000

## Semi-automatic tools

### EXPANSIONSERT 1, EXPANSIONSERT 2

The tool can be integrated into manual lever presses and other pressing devices.

■ For small to medium series



EXPANSIONSERT 1,  
EXPANSIONSERT 2



Example of the use of a tool

d	EXPANSIONSERT 1 Standard item code	EXPANSIONSERT 1 Flange/clinch item code	EXPANSIONSERT 2 item code
M 2.5	–	0263 025 0006	–
M 3	0260 003 0065	0263 003 0006	0264 103 0008
M 3.5	0260 035 5008	0263 035 0075	0264 103 5008
M 4	0260 004 0095	0263 004 0075	0264 104 0095
	0260 004 0008	–	–
M 5	0260 005 0011	0263 005 0085	0264 105 0011
	0260 005 0008	–	–
M 6	0260 006 0125	0263 006 0011	0264 106 0125
M 8	–	–	–
M 10	–	–	–



## Installation tools – QUICKSERT® Expansion Machine installation tools with hydraulic-pneumatic drive

The setting tool P 2005 allows quick and safe installation.

■ For medium and large series

**Item code 2361 550 6000**



Designation	Item code
Threaded mandrel	2361 13x x020
Nosepiece	2361 13x x030

xx = metric dimension,  
example: M 6 = 06 for QUICKSERT® M 6.

# Potential and realised applications

## Diverse industries:

### Plant engineering

- Exhaust ducts of rolling mills

### Store construction

- Bar lighting

### Filter technology

- Fastening of filter frames

### Medical engineering

- Dialysers

### Consumer electronics

- Fastening of decor strips for television sets
- Fastening of loudspeakers

### Mechanical engineering

- Covers of diesel particulate filters

### Crane construction

- Cabin linings

### Forklift trucks

- Electronic assemblies

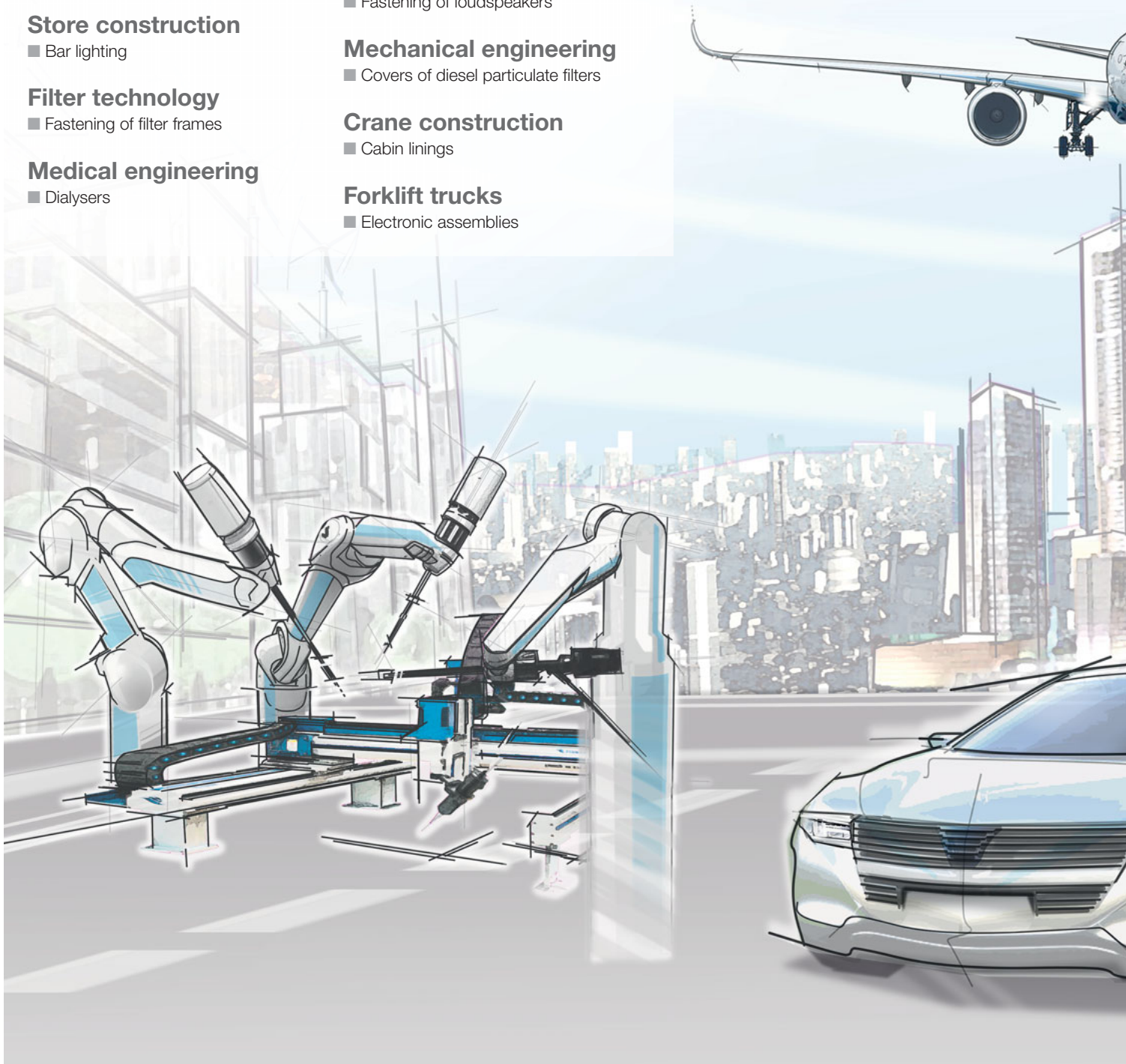

## Customised solutions



HITCERT® hose coupling with temperature-resistant O-ring



Customised special part, silver-plated



Seal thread insert with temperature-resistant O-ring

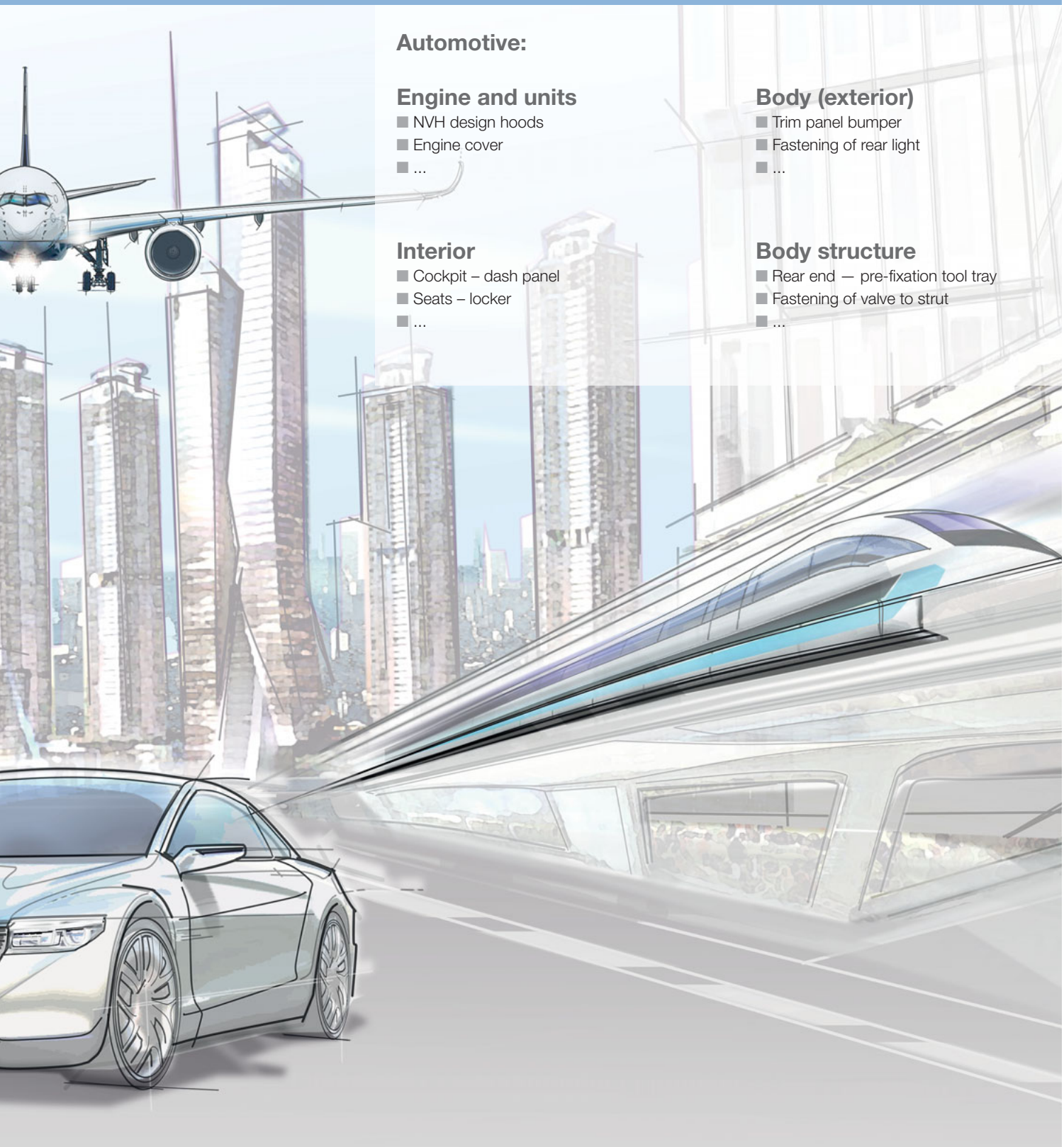

**Automotive:**

**Engine and units**

- NVH design hoods
- Engine cover
- ...

**Interior**

- Cockpit – dash panel
- Seats – locker
- ...

**Body (exterior)**

- Trim panel bumper
- Fastening of rear light
- ...

**Body structure**

- Rear end – pre-fixation tool tray
- Fastening of valve to strut
- ...



EXPANSIONSERT 1  
with hexagon flange/brass



QUICKSERT® Expansion  
expansion thread insert with collar/steel



HITSERT® 3 seal insert  
hose coupling/brass

# BÖLLHOFF



## **Böllhoff Group**

Innovative partner for joining technology with assembly and logistics solutions.

Find your local partner at [www.boellhoff.com](http://www.boellhoff.com) or contact us at [fat@boellhoff.com](mailto:fat@boellhoff.com).

**Passion for successful joining.**