

INSERTS

for **PLASTICS**

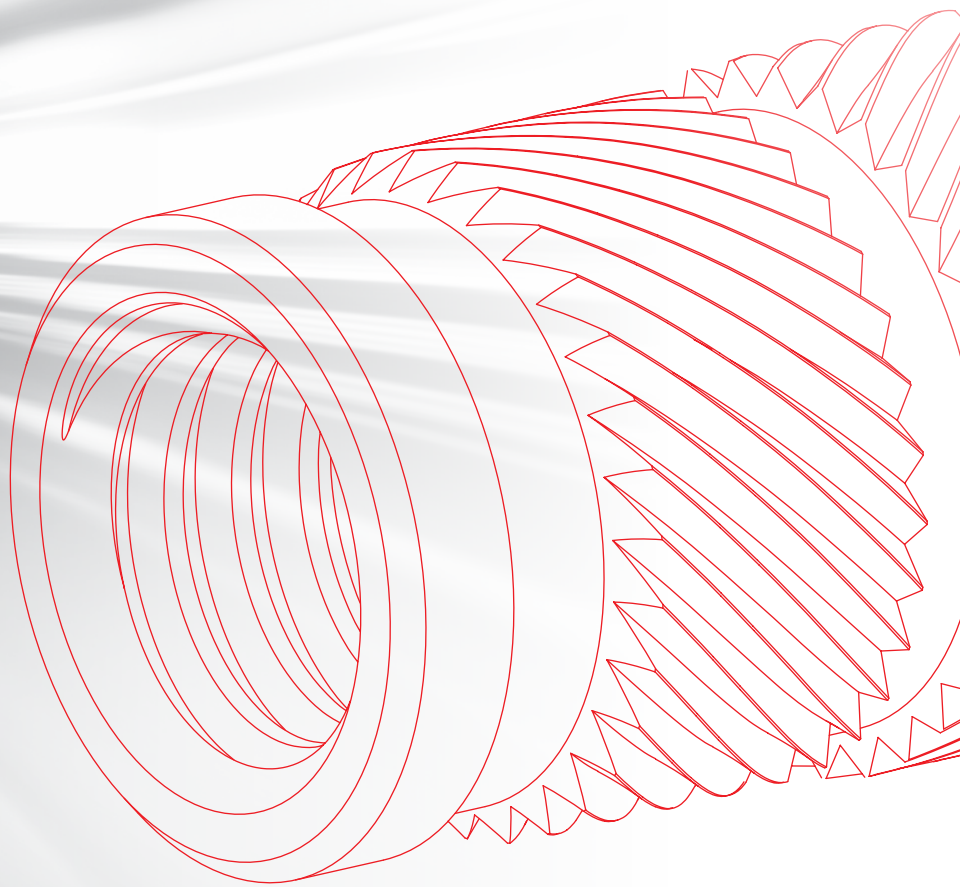

1specialinsert



Specialinsert - proudly a successful presence in the world of fasteners for **35 years**. **Specialinsert** was established in 1974 by three sales agents who decided to exploit their experience in the fasteners industry to start up their own retail business. The company later developed and started its own production.

With three local Branches, three warehouses, one production plant in Italy, R&D office and one Testing laboratory, we supply cutting-edge solutions suited to solving the most diverse fastening problems.

Specialinsert products range span from threaded tubular inserts and bushings for plastic materials to inserts for wood, Self-tapping inserts and ¼ quick-turn fasteners.

Specialinsert production is entirely made in Italy at the Maerne plant. The company's Quality System has been certified by ICIM since 1997.

Specialinsert's mission is to establish ourselves on the market as an innovative, continuously evolving company and to increasingly offer more and more state-of-the-art solutions and services in step with - and even ahead of - times.



PRODUCTS

METAL SHEETS

Inserts for metal sheets sections



SOLID PARTS

Inserts for solid wood-metal parts



PLASTIC

Plastic material inserts



COMPOSITES

Inserts for composite materials



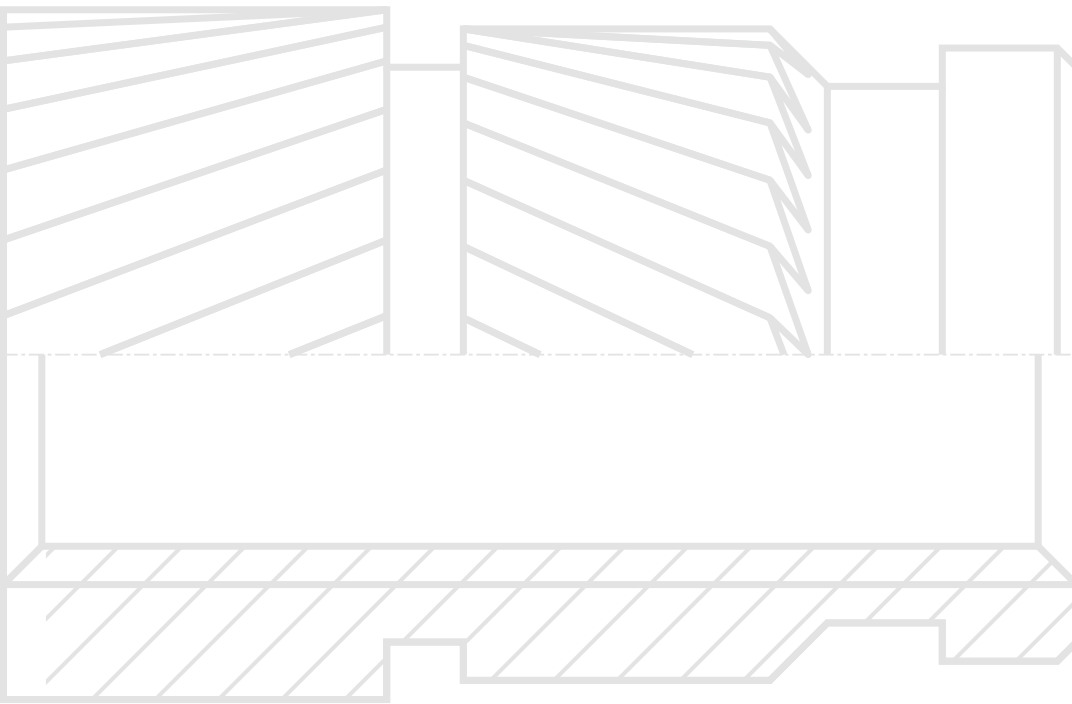

B-LOK® / INSERT-PLASTpage 04

- Series 812 - 815
- Series 821 - 823
- Series 841 - 842
- Series Insert-Plast (standard type)
- Series IPR2

MUBUX®page 10

- Series 850 - 852
- Series 856 - 857

S-LOK® / INSERT-PLAST NTpage 13

- Series 860 - 861 - 862
- Series 863 - 864
- Series 853 - 854 - 855
- Series Insert-Plast (without slot)
- Series 866 - 867
- Series 858 - 859
- Series 60_ /C - 62_ /C
- Series ES
- Series ES CH

ENSAT®page 23

- Series 302
- Series 303
- Series 305
- Series 307 - 308
- Series 309
- Series 337 - 338
- Series 347 - 348

CONVERSION TABLEpage 33

INSERT FOR PLASTIC SHEETSpage 34

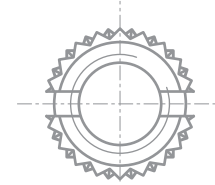

B-LOK®

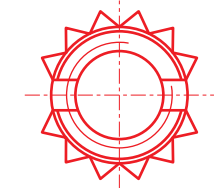

**INSERT
PLAST**

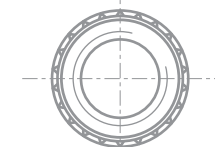

MUBUX®

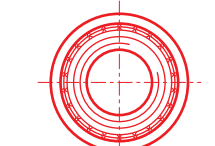

S-LOK®



ES

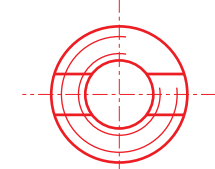

ENSAT®

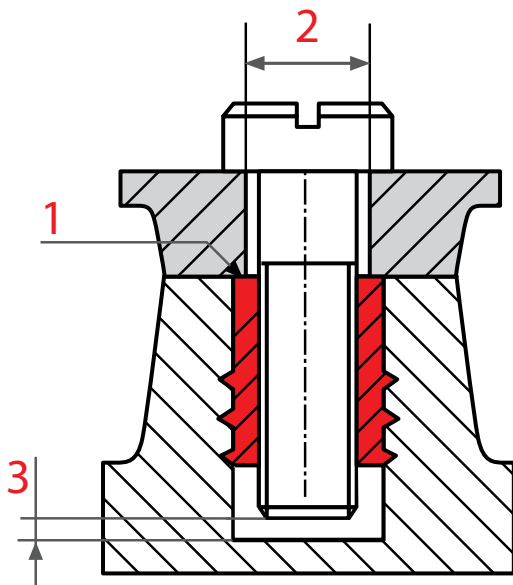

1-2

The seat should be prepared during moulding. Insert the bush by pressing it in with a suitable punch. Do not use punches with guide pins so that the bush is able to contract during insertion.

3

When the screw is inserted, the bush will expand so it is anchored to the walls of the hole. The residual tension creates a slight self-locking effect on the screw.

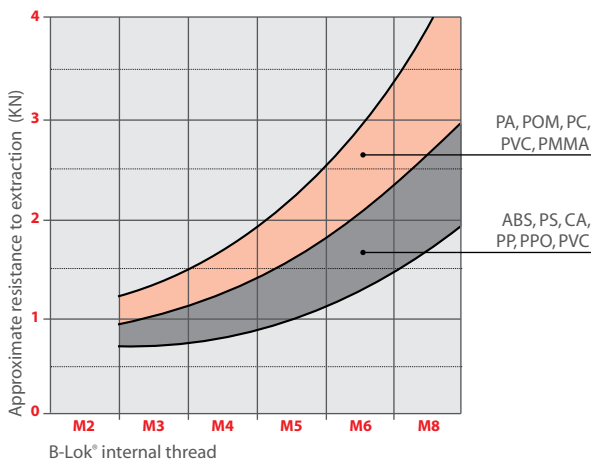

Function testing is recommended.

Approximate values; only applicable if at least 50% of the length of the screw is inserted into the threaded insert.

THREADED INSERTS

“Press-in and expansion” insertion mode.

The B-Lok® and Insert-Plast are threaded inserts with various external sections that guarantee an excellent fastening with any type of plastics, preferably moulded.

The IPR2 is a threaded insert with a special outer shape capable of standing up to high torsion loads. This series is inserted by means of pressure and is anchored by means of expansion.

INSTALLATION

The position of the insert must be flush with the assembly surface (1); the hole (2) on the item to be connected must be the correct dimension so that a contrast is created with the head of the bush, preventing its extraction due to lever action.

The length of the screw must be calculated so that the entire length of the thread of the bush is used to obtain maximum expansion. Make sure the screw does not come into contact with the bottom of the hole (3) to prevent the bush from coming out.

The design of the seat, hole size and wall thickness depend on the material used. Flared or bevelled shapes are not recommended. Refer to the technical specifications for the measurements.

To safeguard correct use of the product, we recommend assembly testing in order to establish the exact diameter of the hole.

The depth of the hole must be greater than the length of the bush.

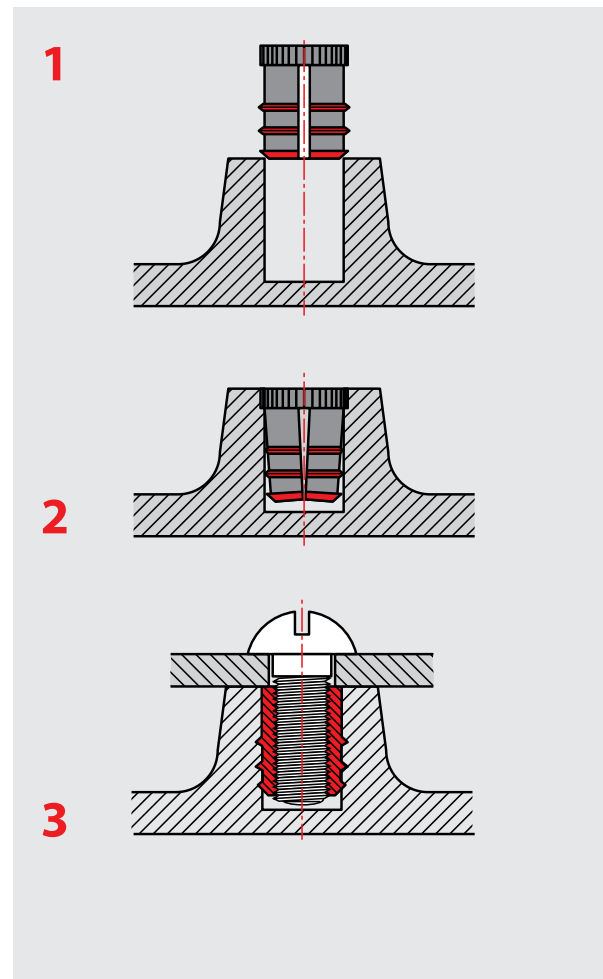

B-Lok® SERIES 812 - 815



SELF-LOCKING EXPANSION INSERTS

APPLICATION

Thermoplastic materials.

ASSEMBLY

By pressure through expansion anchorage.

PRODUCT		CODE	Metric thread	External diameter	Total length	Number of Vanes	Minimum wall thickness	Hole diameter
S**	R***		(d1)	(d2)	(L)		(S)	(d3 ^{+0.04})
	●	812 0020.80	M 2	3.45	4.0	2	1.6	3.2
	●	813 0025.80	M 2.5	4.3	4.8	3	2.0	4.0
●		813 0030.80	M 3	4.3	4.8	3	2.0	4.0
	●	813 0035.80	M 3.5	5.1	6.4	3	2.4	4.8
●		814 0040.80	M 4	5.9	8.0	4	2.8	5.6
●		815 0050.80	M 5	6.7	9.5	5	3.2	6.4
●		815 0060.80	M 6	8.3	12.7	5	4.0	8.0
●		815 0080.80	M 8	9.9	12.7	5	4.8	9.5

S** standard	R*** on demand
-----------------	-------------------

• MATERIAL

Brass

• FINISHING

Natural

• TOLERANCES

ISO 2768-m

• THREADING d1

ISO 6H

• EXAMPLE OF CODE DESIGNATION

Insert B-Lok® M 5 thread, brass: **815 0050.80**

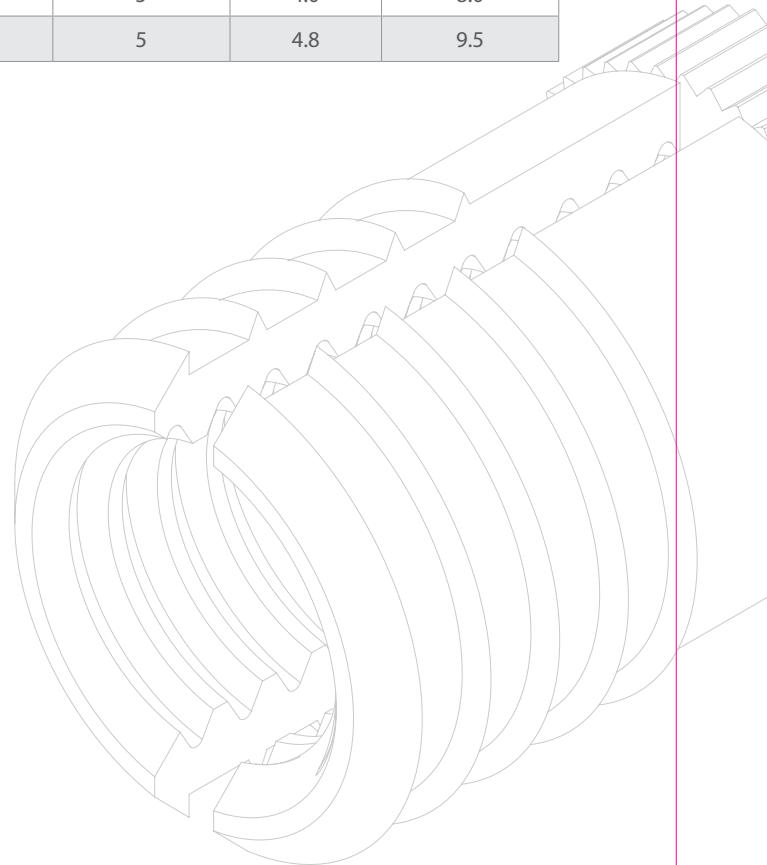

Non binding dimensions, expressed in mm.

For a correct usage of the product it is advisable to carry out some preliminary assembling tests to determine the correct hole diameter.

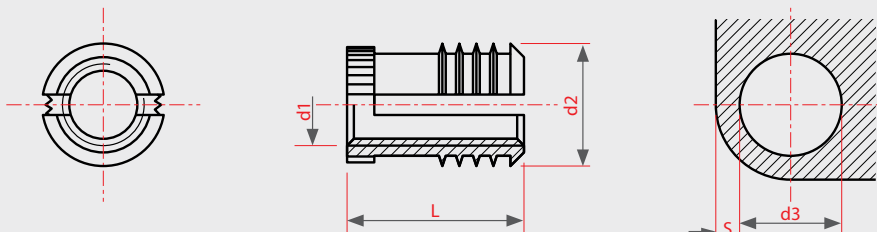

B-Lok® SERIES 821 - 823

SELF-LOCKING EXPANSION
INSERTS

APPLICATION

Thermoplastic and fibrous materials.

ASSEMBLY

By pressure through expansion anchorage.



PRODUCT		CODE	Metric thread	External diameter	Total length	Number of Vanes	Hole diameter
S**	R***		(d1)	(d2)	(L)		(d3)
	●	821 0030.80	M 3	5.35	4.8	1	4.5 ÷ 4.7
	●	822 0040.80	M 4	6.65	9.5	2	5.8 ÷ 6.0
	●	822 0050.80	M 5	7.35	9.5	2	6.5 ÷ 6.7
	●	822 0060.80	M 6	9.05	9.5	2	8.2 ÷ 8.4
	●	823 0080.80	M 8	12.5	14.3	3	11.8 ÷ 12.0

S** standard	R*** on demand
------------------------	--------------------------

- **MATERIAL**
Brass
- **FINISHING**
Natural
- **TOLERANCES**
ISO 2768-m
- **THREADING d1**
ISO 6H
- **EXAMPLE OF CODE DESIGNATION**
Insert B-Lok® M 5 thread, brass: **822 0050.80**

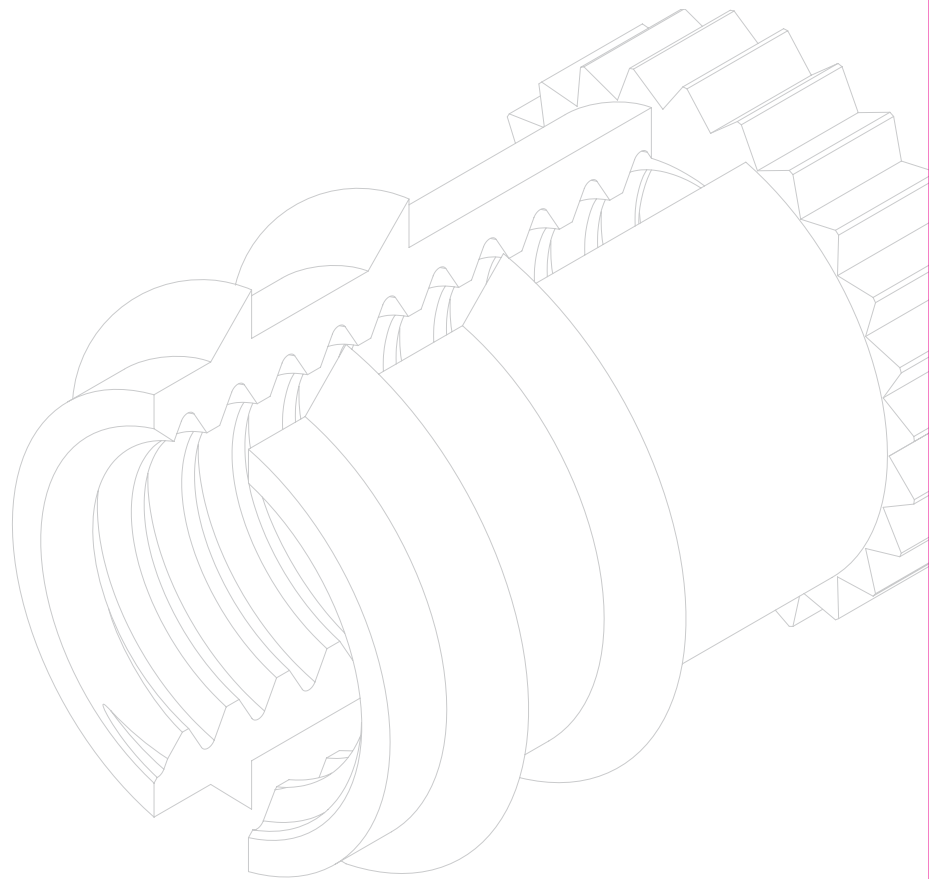

Non binding dimensions, expressed in mm.

For a correct usage of the product it is advisable to carry out some preliminary assembling tests to determine the correct hole diameter.

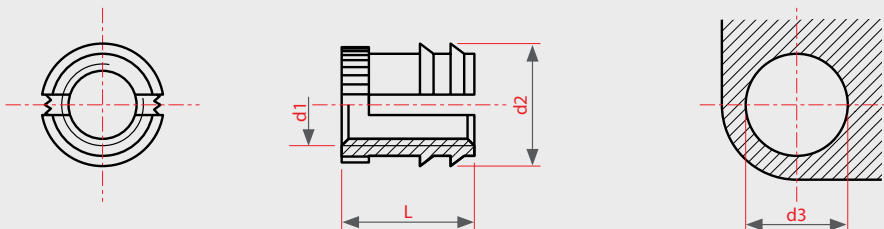

B-Lok® SERIES 841 - 842



SELF-LOCKING EXPANSION INSERTS

APPLICATION

Thermosetting materials.

ASSEMBLY

By pressure through expansion anchorage.

SERIES 841

PRODUCT		CODE	Metric thread	External diameter	Total length	Minimum wall thickness	Hole diameter
S**	R***		(d1)	(d2)	(L)	(S)	(d3)
	●	841 0020.80	M 2	3.55	4.0	2.4	3.2 ÷ 3.3
	●	841 0025.80	M 2.5	4.3	4.8	3.2	4.0 ÷ 4.1
●		841 0030.80	M 3	4.3	4.8	3.2	4.0 ÷ 4.1
	●	841 0035.80	M 3.5	5.1	6.4	3.6	4.7 ÷ 4.8
●		841 0040.80	M 4	6	8.0	4.0	5.5 ÷ 5.6
●		841 0050.80	M 5	6.8	9.5	4.8	6.3 ÷ 6.4
●		841 0060.80	M 6	8.4	12.7	6.0	7.9 ÷ 8.0
●		841 0080.80	M 8	9.9	12.7	7.0	9.5 ÷ 9.6

SERIES 842

PRODUCT		CODE	Metric thread	External diameter	Total length	Head diameter	Head thickness	Minimum wall thickness	Hole diameter
S**	R***		(d1)	(d2)	(L1)	(d4)	(L3)	(S)	(d3)
	●	842 0020.80	M 2	3.55	4.0	4.8	0.6	2.4	3.2 ÷ 3.3
	●	842 0025.80	M 2.5	4.3	4.8	5.6	0.6	3.2	4.0 ÷ 4.1
●		842 0030.80	M 3	4.3	4.8	5.6	0.6	3.2	4.0 ÷ 4.1
	●	842 0035.80	M 3.5	5.1	6.4	6.4	0.8	3.6	4.7 ÷ 4.8
●		842 0040.80	M 4	6	8.0	7.2	0.8	4.0	5.5 ÷ 5.6
●		842 0050.80	M 5	6.8	9.5	8.0	1.0	4.8	6.3 ÷ 6.4
●		842 0060.80	M 6	8.4	12.7	9.5	1.3	6.0	7.9 ÷ 8.0
●		842 0080.80	M 8	9.9	12.7	11.0	1.3	7.0	9.5 ÷ 9.6

• MATERIAL

Brass

• FINISHING

Natural

• TOLERANCES

ISO 2768-m

• THREADING d1

ISO 6H

• EXAMPLE OF CODE DESIGNATION

Insert B-Lok® with head, knurled, M 5 thread, brass: **842 0050.80**

S** standard	R*** on demand
-----------------	-------------------

Non binding dimensions, expressed in mm.

For a correct usage of the product it is advisable to carry out some preliminary assembling tests to determine the correct hole diameter.

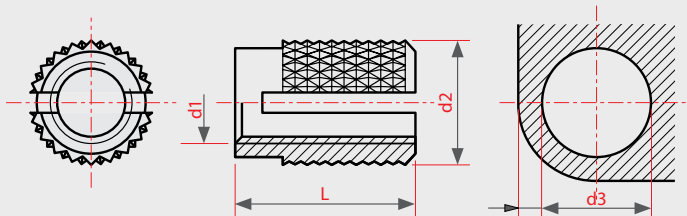

SERIES 841

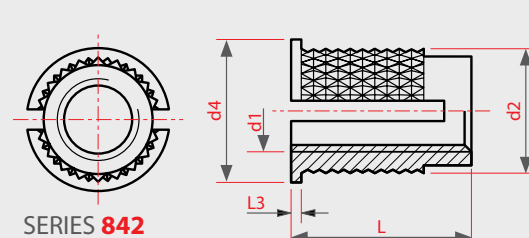

SERIES 842

SERIES INSERT-PLAST STANDARD TYPE

THREADED EXPANSION INSERT

APPLICATION
Thermoplastic materials.
ASSEMBLY
By pressure with expansion.



PRODUCT		CODE	Metric thread	Crown diameter	Total length	Number of crowns	Hole diameter*
S**	R***		(d1)	(d2)	(L)		(d3)
●		M. 2 C.03.5 ⓘ	M 2	4	3.5	1	3.2
●		M. 2,5 C.04 ⓘ	M 2.5	4.5	4	1	3.5
	●	M. 3 C.04	M 3	5.6	4	1	4.7
●		M. 3 C.05			5	1	
●		M. 3 E.08			8	2	
●		M. 3 D.09.5			9.5	2	
●		M. 3,5 C.05	M 3.5	6	5	1	5.1
	●	M. 3,5 E.08			8	2	
●		M. 3,5 D.09.5			9.5	2	
●		M. 4 C.05	M 4	6.6	5	1	5.6
●		M. 4 E.08			8	2	
●		M. 4 D.09.5			9.5	2	
●		M. 5 C.06	M 5	7.6	6	1	6.8
●		M. 5 D.09			9	2	
●		M. 6 C.07	M 6	8.6	7	1	7.7
●		M. 6 D.09			9	2	
●		M. 8 D.10	M 8	10.6	10	2	9.6

S** standard	R*** on demand
------------------------	--------------------------

* Hole diameter varies depending on the receiving material.

• **MATERIAL**

Brass

• **FINISHING**

Natural

• **TOLERANCES**

ISO 2768-m

• **THREADING d1**

ISO 6H

• **EXAMPLE OF CODE DESIGNATION**

Threaded expansion bushing, M 5 thread, 9 mm length, brass: **M.5 D.09**



The upper bevel angle is not usually provided for M 2 and M 2.5 threads.

Use screws of suitable length in order to make use of the whole thread of the bush.

Non binding dimensions, expressed in mm.

In order to use correctly the products, we suggest to carry out some preliminary assembly tests to determine the right hole.

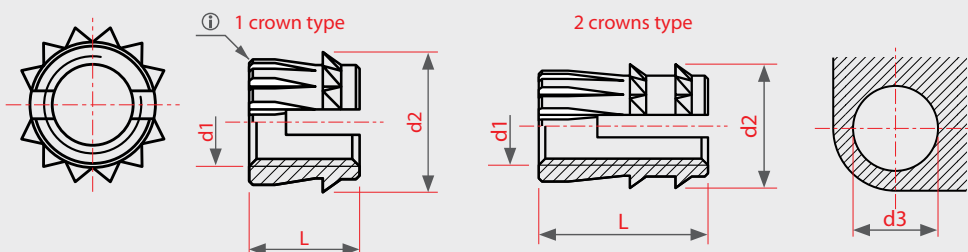

Insert - Plast SERIES IPR2



HIGH PERFORMANCE THREADED
EXPANSION INSERT

APPLICATION

Thermoplastic materials.

ASSEMBLY

By pressure through expansion anchorage.

PRODUCT		CODE	Metric thread	Anchorage dimension	External diameter	Head thickness	Head diameter	Hole diameter*	Minimum thickness
S**	R***		(d1)	(L)	(d)	(S)	(d2)	(d3)	(s1)
	●	IPR2 0 060.80	M 6	10	8.4	1.3	12	7.6	6

S** standard	R*** on demand
-----------------	-------------------

* Hole diameter might change depending on the receiving materials.

• MATERIAL

Brass

• FINISHING

Natural

• TOLERANCES

ISO 2768-m

• THREADING d1

Metric ISO 6H

• EXAMPLE OF CODE DESIGNATION

High resistance threaded expansion bushings, thread M 6, brass material: **IPR2 0 060.80**

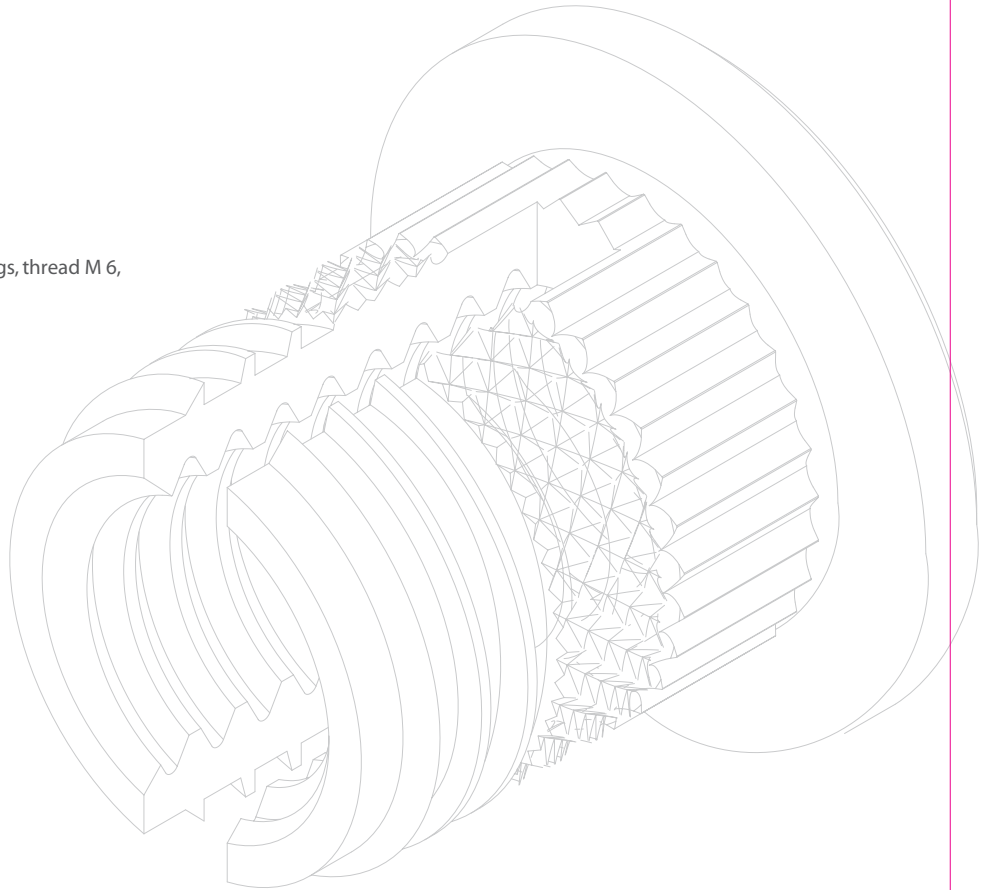

Use screws with proper length in order to exploit the total length of thread of the bushing.

Non binding dimensions, expressed in mm.

For a correct usage of the product it is advisable to carry out some preliminary assembling tests to determine the correct hole diameter.

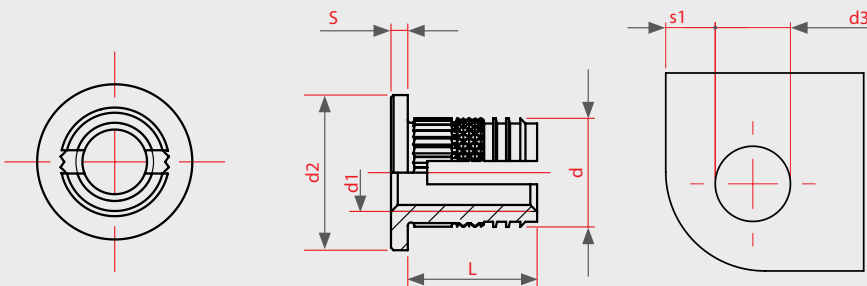

THREADED INSERTS AND GRUB SCREWS

“Press-in” insertion mode

The **Mubux**® is a threaded insert with angled outer ribs, broken by small drainage grooves designed for rigid, preferably moulded thermoplastics. Its section allows the bush to cut the material of the receiving seat, reducing radial strain and therefore enabling applications on seats with thin walls. “Press-in” insertion mode.



INSTALLATION

A punch that allows the bush to turn in the same direction as the ribbing during insertion is required for the assembly process. Press in gradually and avoid ramming.

The position of the insert must be flush with the assembly surface. The hole on the item to be connected must be the correct dimension so that a contrast is created with the head of the insert, preventing its extraction due to lever action. The length of the screw must be calculated so that the entire length of the thread of the bush is used. Make sure the screw does not come into contact with the bottom of the hole to prevent it from coming out.

The design of the seat, hole size and wall thickness depend on the material used. Flared or bevelled shapes are not recommended. Refer to the technical specifications for the measurements.

To safeguard correct use of the product, we recommend assembly testing in order to establish the exact diameter of the hole.

The depth of the hole must be greater than the length of the bush.

The seat should be created during moulding. Put the insert into position with the lead-in area facing the hole; press in the insert using a suitable punch, allowing it to turn in the direction of the ribbing. Press in slowly and gradually and avoid ramming.

The bush should be fitted onto the item immediately after moulding, whenever possible.

The **Mubux**® has given excellent results with several thermosets using an ultrasound insertion process.

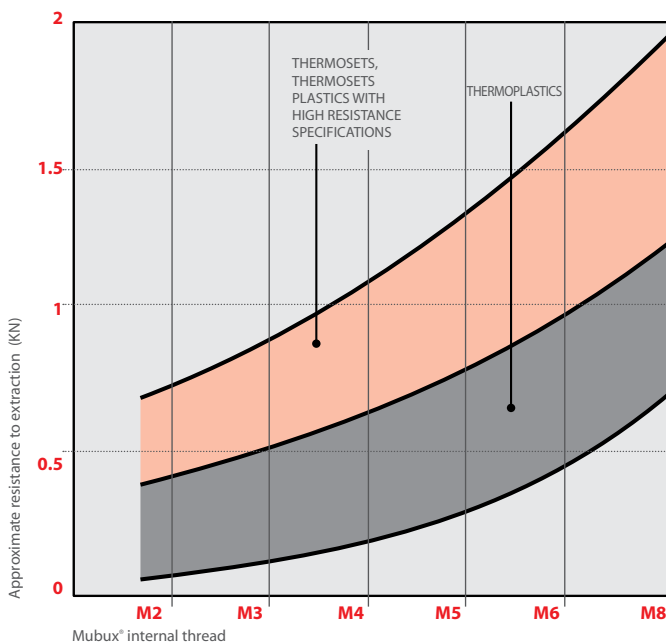

Function testing is recommended.

Approximate values; only applicable if at least 50% of the length of the screw is inserted into the threaded insert.

Mubux® SERIES 850 - 852



PRESSED-IN THREADED INSERTS

APPLICATION

Rigid thermoplastic materials.

ASSEMBLY

By pressure.

SERIES 850

PRODUCT		CODE	Metric thread	External diameter	Total length	Hole diameter	Minimum wall thickness
S**	R***		(d1)	(d2)	(L)	(d3)	(S)
	●	850 0020.80	M 2	3.35	4.0	3.1	1.6
	●	850 0025.80	M 2.5	4.2	5.3	3.7	2.0
●		850 0030.80	M 3	4.2	5.3	3.7	2.0
	●	850 0035.80	M 3.5	5.0	6.3	4.5	2.5
●		850 0040.80	M 4	5.8	7.4	5.3	2.5
●		850 0050.80	M 5	6.6	8.3	6.1	2.5
●		850 0060.80	M 6	8.2	9.2	7.7	2.8
●		850 0080.80	M 8	9.7	9.2	9.2	3.8
	●	850 0100.80	M 10	12.0	9.2	11.6	5.5

SERIES 852

PRODUCT		CODE	Metric thread	External diameter	Head diameter	Head thickness	Anchorage dimension	Hole diameter	Minimum wall thickness
S**	R***		(d1)	(d2)	(d4)	(L2)	(L1)	(d3)	(S)
	●	852 0020.80	M 2	3.35	4.8	0.6	4.0	3.1	1.6
	●	852 0025.80	M 2.5	4.2	5.6	0.6	5.3	3.7	2.0
●		852 0030.80	M 3	4.2	5.6	0.6	5.3	3.7	2.0
	●	852 0035.80	M 3.5	5.0	6.4	0.8	6.3	4.5	2.5
●		852 0040.80	M 4	5.8	7.2	0.8	7.4	5.3	2.5
●		852 0050.80	M 5	6.6	8.0	1.0	8.3	6.1	2.5
●		852 0060.80	M 6	8.2	9.5	1.3	9.2	7.7	2.8
●		852 0080.80	M 8	9.7	11.0	1.3	9.2	9.2	3.8
	●	852 0100.80	M 10	12.0	14.0	1.6	9.2	11.6	5.5

S**
standard

R***
on demand

• MATERIAL

Brass

• FINISHING

Natural

• TOLERANCES

ISO 2768-m

• THREADING d1

ISO 6H

• EXAMPLE OF CODE DESIGNATION

Threaded insert Mubux® with head, M 5 thread, brass: **852 0050.80**

Non binding dimensions, expressed in mm.

For a correct usage of the product it is advisable to carry out some preliminary assembling tests to determine the correct hole diameter.

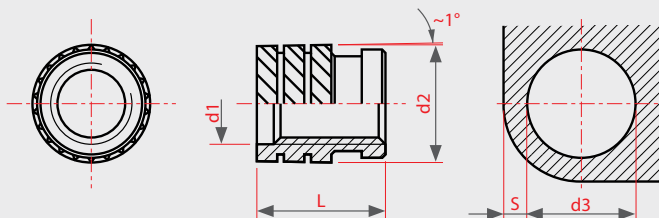

SERIES 850

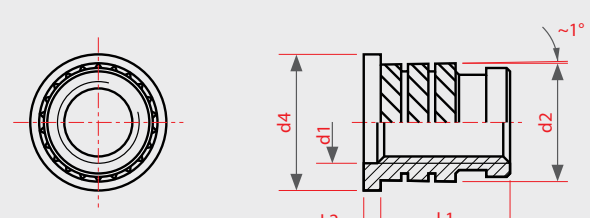

SERIES 852

Mubux® SERIES 856- 857

PRESSED-IN THREADED STUDS

APPLICATION

Rigid thermoplastic materials.

ASSEMBLY

By pressure.



SERIES 856

PRODUCT		CODE	Metric thread	External diameter	Anchorage dimension	Hole diameter	Minimum wall thickness
S**	R***		(d1)	(d2)	(L1)	(d3)	(S)
	●	856 0020.8_	M 2	3.35	4.0	3.1	1.6
	●	856 0025.8_	M 2.5	4.2	5.3	3.8	2.0
	●	856 0030.8_	M 3	4.2	5.3	3.8	2.0
	●	856 0035.8_	M 3.5	5.0	6.3	4.6	2.5
	●	856 0040.8_	M 4	5.8	7.4	5.4	2.5
	●	856 0050.8_	M 5	6.6	8.3	6.2	2.5
	●	856 0060.8_	M 6	8.2	9.2	7.8	2.8
	●	856 0080.8_	M 8	9.7	9.2	9.3	3.8

AVAILABLE STUD LENGTH (TABLE 1)

CODE final data	Stud length			
	(L3)	M 2 M 2.5	M 3 M 3.5 M 4	M 5 M 6 M 8
_____2	6	●	●	●
_____4	10	●	●	●
_____6	16	●	●	●
_____8	25	●	●	●

THREAD LENGTH L4 = L3 - 2P
P = THREAD PITCH

SERIES 857

PRODUCT		CODE	Metric thread	External diameter	Head diameter	Head thickness	Anchorage dimension	Hole diameter	Minimum wall thickness
S**	R***		(d1)	(d2)	(d4)	(L2)	(L1)	(d3)	(S)
	●	857 0020.8_	M 2	3.35	4.8	0.6	4.0	3.1	1.6
	●	857 0025.8_	M 2.5	4.2	5.6	0.6	5.3	3.8	2.0
	●	857 0030.8_	M 3	4.2	5.6	0.6	5.3	3.8	2.0
	●	857 0035.8_	M 3.5	5.0	6.4	0.8	6.3	4.6	2.5
	●	857 0040.8_	M 4	5.8	7.2	0.8	7.4	5.4	2.5
	●	857 0050.8_	M 5	6.6	8.0	1.0	8.3	6.2	2.5
	●	857 0060.8_	M 6	8.2	9.5	1.3	9.2	7.8	2.8
	●	857 0080.8_	M 8	9.7	11.0	1.3	9.2	9.3	3.8

• MATERIAL

Brass

• FINISHING

Natural

• TOLERANCES

ISO 2768-m

• THREADING d1

ISO 6g

• EXAMPLE OF CODE DESIGNATION

Threaded insert Mubux®, M 5 thread, brass, stud length 16 mm: **856 0050.86**

S** standard	R*** on demand
-----------------	-------------------

Non binding dimensions, expressed in mm.

For a correct usage of the product it is advisable to carry out some preliminary assembling tests to determine the correct hole diameter.

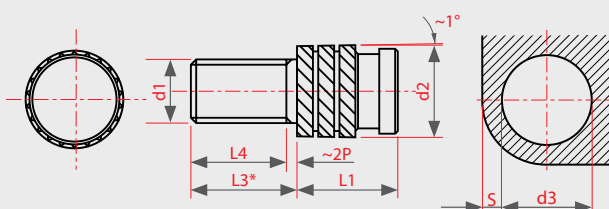

SERIES 856

* stud length L3: see Table 1.

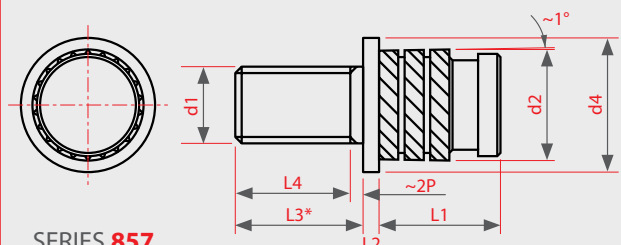

SERIES 857

* stud length L3: see Table 1.

THREADED INSERTS AND STUDS SCREWS

Insertion using ultrasound, heat, co-moulding

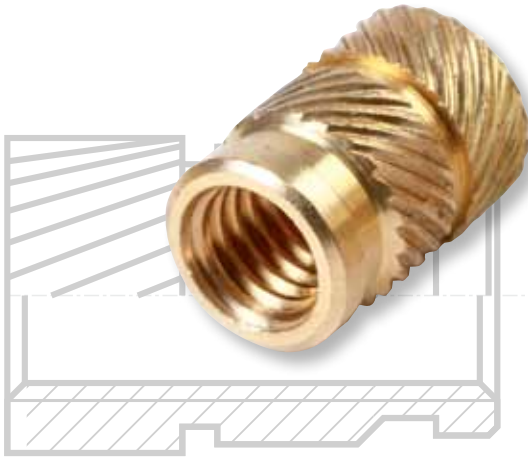

The **S-Lok®** is a threaded insert whose external section has two areas of angled ribbing running in opposite directions, broken by small drainage grooves. Designed for thermoplastics with insertion by heat or ultrasound, or inserted during moulding for other plastics.

The **Insert-Plast NT** is a threaded insert whose outer surface has one or two notched rims. The special design of the notches offers greater resistance to traction and torsion. Designed for thermoplastics with insertion by heat or ultrasound, or inserted during moulding for other plastics. The **ES** is a threaded insert with a hexagonal outer shape broken by grooves to contain the plastic during moulding. Its special shape guarantees greater torsion and traction stress.

The **ES** series can only be applied during co-moulding processes.

INSTALLATION

The assembly process can be by heating the bush or by ultrasound. Avoid excessive strain to allow the plastic, softened by the heat, to flow evenly and envelop all of the shape of the insert. For co-moulding processes, the bush is fitted during the moulding of the item in plastic. The insert is put inside the mould before the injection of the plastic and remains in position throughout the cooling stage. This process guarantees a greater response to traction and torsion strain.

The position of the insert must be flush with the assembly surface. The hole on the item to be connected must be the correct dimension so that a contrast is created with the head of the insert, preventing its extraction due to lever action. The length of the screw must be calculated so that the entire length of the thread of the bush is used. Make sure the screw does not come into contact with the bottom of the hole to prevent it from coming out.

The design of the seat, hole size and wall thickness depend on the material used. Flared or bevelled shapes are not recommended. If a tapered hole is required, we recommend the 853-854 series for easier removal of the part from the mould.

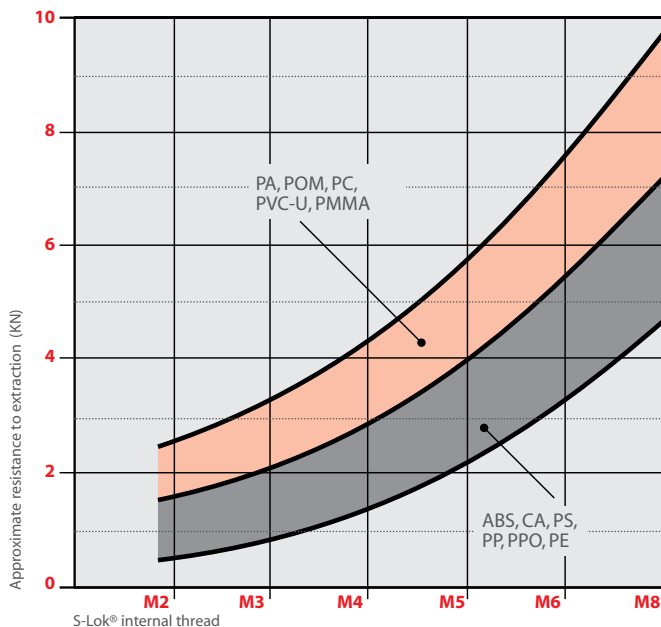

Function testing is recommended.

Approximate values; only applicable if at least 50% of the length of the screw is inserted into the threaded insert.

S-Lok® SERIES 860 - 861 - 862

THREADED INSERTS

APPLICATION	ASSEMBLY
Thermoplastic materials.	Ultrasonic, heat, overmoulding.
Thermosetting materials.	Overmoulding.



SERIES 860 - 861

PRODUCT		CODE	Metric thread	External diameter	Total length	Hole diameter	Minimum wall thickness	CODE	Total length
S**	R***		(d1)	(d2)	(L)	(d3)	(S)		(L)
	●	860 0 020.80	M 2	3.6	4.0	3.2	2.0	-	-
	●	860 0 025.80	M 2.5	4.6	5.8	4.0	2.3	861 0025.80	4.0
●		860 0 030.80	M 3	4.6	5.8	4.0	2.3	861 0030.80	4.0
	●	860 0 035.80	M 3.5	5.4	7.2	4.8	2.5	861 035.80	5.8
●		860 0 040.80	M 4	6.3	8.2	5.6	2.5	861 0040.80	7.2
●		860 0 050.80	M 5	7.0	9.5	6.4	2.7	861 0050.80	8.2
●		860 0 060.80	M 6	8.6	12.7	8.0	3.0	861 0060.80	9.5
●		860 0 080.80	M 8	10.2	12.7	9.6	3.5	861 0080.80	9.5
	●	860 0 100.80	M 10	12.3	12.7	11.7	4.0	861 0100.80	9.5

SERIES 862

PRODOTTO		CODICE	Metric thread	External diameter	Head diameter	Thickness head	Anchorage dimension	Hole diameter	Minimum wall thickness
S**	R***		(d1)	(d2)	(d4)	(L2)	(L1)	(d3)	(S)
	●	862 0020.80	M 2	3.6	4.8	0.6	4.0	3.2	2.0
	●	862 0025.80	M 2.5	4.6	5.6	0.6	5.8	4.0	2.3
●		862 0030.80	M 3	4.6	5.6	0.6	5.8	4.0	2.3
	●	862 0035.80	M 3.5	5.4	6.4	0.8	7.2	4.8	2.5
●		862 0040.80	M 4	6.3	7.2	0.8	8.2	5.6	2.5
●		862 0050.80	M 5	7.0	8.0	1.0	9.5	6.4	2.7
●		862 0060.80	M 6	8.6	9.5	1.3	12.7	8.0	3.0
●		862 0080.80	M 8	10.2	11.0	1.3	12.7	9.6	3.5
	●	862 0100.80	M 10	12.3	14.0	1.3	12.7	11.7	4.0

• MATERIAL

Brass

• FINISHING

Natural

• TOLERANCES

ISO 2768-m

• THREADING d1

ISO 6H

• EXAMPLE OF CODE DESIGNATION

Threaded insert S-Lok® with head, M 5 thread, brass: **862 0050.80**

S** standard	R*** on demand
-----------------	-------------------

Non binding dimensions, expressed in mm.

For a correct usage of the product it is advisable to carry out some preliminary assembling tests to determine the correct hole diameter.

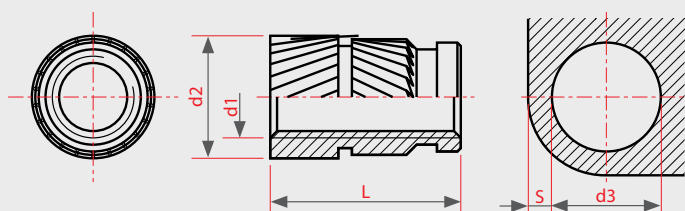

SERIES 860 - 861

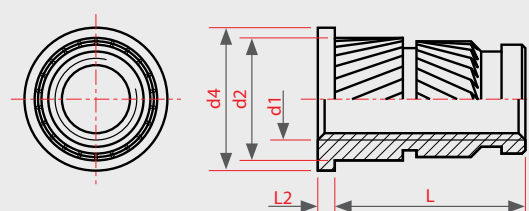

SERIES 862

S-Lok® SERIES 863 - 864



SYMMETRICAL THREADED INSERTS

APPLICATION	ASSEMBLY
Thermoplastic materials.	Ultrasonic, heat, overmoulding.
Thermosetting materials.	Overmoulding.
Important for automatic assembly.	

SERIES 863

PRODUCT		CODE	Metric thread	External diameter	Total length	Hole diameter	Minimum wall thickness
S**	R***		(d1)	(d2)	(L)	(d3)	(S)
	●	863 0020.80	M 2	3.5	4.0	3.2	1.5
	●	863 0025.80	M 2.5	4.4	5.8	4.0	1.8
	●	863 0030.80	M 3	4.4	5.8	4.0	1.8
	●	863 0035.80	M 3.5	5.2	7.2	4.8	2.2
	●	863 0040.80	M 4	6.0	8.2	5.6	2.5
	●	863 0050.80	M 5	6.8	9.5	6.4	3
	●	863 0060.80	M 6	8.4	12.7	8.0	3.5
	●	863 0080.80	M 8	10.0	12.7	9.6	4.5
	●	863 0100.80	M 10	12.3	12.7	11.9	5.5

The use of S-Lok® 863 is particularly suggested for polycarbonates or plastic materials subject to cracks.

SERIES 864

PRODUCT		CODE	Metric thread	External diameter	Total length	Hole diameter	Minimum wall thickness
S**	R***		(d1)	(d2)	(L)	(d3)	(S)
	●	864 0020.80	M 2	3.5	4.0	3.2	1.5
	●	864 0025.80	M 2.5	4.4	5.8	4.0	1.8
	●	864 0030.80	M 3	4.4	5.8	4.0	1.8
	●	864 0035.80	M 3.5	5.2	7.2	4.8	2.2
	●	864 0040.80	M 4	6.0	8.2	5.6	2.5
	●	864 0050.80	M 5	6.8	9.5	6.4	3
	●	864 0060.80	M 6	8.4	12.7	8.0	3.5
	●	864 0080.80	M 8	10.0	12.7	9.6	4.5
	●	864 0100.80	M 10	12.3	12.7	11.9	5.5

• **MATERIAL**

Brass

• **FINISHING**

Natural

• **TOLERANCES**

ISO 2768-m

• **THREADING d1**

ISO 6H

• **EXAMPLE OF CODE DESIGNATION**

Threaded insert S-Lok® for polycarbonates, M 5 thread, brass: **863 0050.80**

S** standard	R*** on demand
-----------------	-------------------

Non binding dimensions, expressed in mm.

For a correct usage of the product it is advisable to carry out some preliminary assembling tests to determine the correct hole diameter.

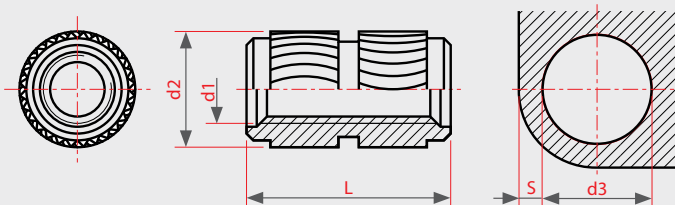

SERIES 863

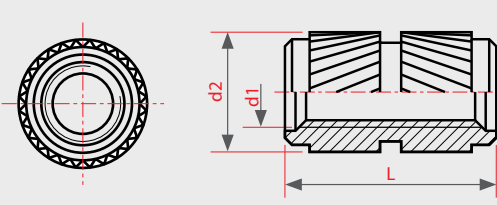

SERIES 864

S-Lok® SERIES 853 - 854 - 855

THREADED INSERTS

APPLICATION	ASSEMBLY
Thermoplastic materials.	Ultrasonic, heat, overmoulding.
Thermosetting materials.	Overmoulding.



SERIES 853 - 854

PRODUCT		CODE	Metric thread	External diameter	Total length	Hole diameter	Minimum wall thickness	CODE	Total length
S**	R***		(d1)	(d2)	(L)	(d3 ^{+0.1})	(S)		(L)
	●	853 1020.80	M 2	4.1	5.0	3.8	1.5	-	-
	●	853 1025.80	M 2.5	4.1	5.0	3.8	1.5	-	-
	●	853 1030.80	M 3	4.6	5.5	4.4	1.8	854 1030.80	5.0
	●	853 1035.80	M 3.5	5.4	6.0	5.2	1.8	854 1035.80	5.5
	●	853 1040.80	M 4	6.0	7.5	5.8	2.0	854 1040.80	6.0
	●	853 1050.80	M 5	7.2	9.0	6.9	2.0	854 1050.80	7.5
	●	853 1060.80	M 6	8.8	10.0	8.5	2.5	854 1060.80	9.0
	●	853 1080.80	M 8	11.2	12.0	10.9	3.0	854 1080.80	10.0

SERIES 855

PRODUCT		CODE	Metric thread	External diameter	Head diameter	Head thickness	Anchorage dimension	Hole diameter	Minimum wall thickness
S**	R***		(d1)	(d2)	(d4)	(L2)	(L1)	(d3 ^{+0.1})	(S)
	●	855 1020.80	M 2	4.1	5.6	0.6	5.0	3.8	1.5
	●	855 1025.80	M 2.5	4.1	5.6	0.6	5.0	3.8	1.5
	●	855 1030.80	M 3	4.6	6.4	0.6	5.5	4.4	1.8
	●	855 1035.80	M 3.5	5.4	7.2	0.8	6.0	5.2	1.8
	●	855 1040.80	M 4	6.0	8.0	0.8	7.5	5.8	2.0
	●	855 1050.80	M 5	7.2	9.0	1.0	9.0	6.9	2.0
	●	855 1060.80	M 6	8.8	10.0	1.3	10.0	8.5	2.5
	●	855 1080.80	M 8	11.2	12.5	1.3	12.0	10.9	3.0

S** standard	R*** on demand
-----------------	-------------------

- **MATERIAL**
Brass
- **FINISHING**
Natural
- **TOLERANCES**
ISO 2768-m
- **THREADING d1**
ISO 6H
- **EXAMPLE OF CODE DESIGNATION**
Insert S-Lok® with head, M 5 thread, brass: **855 1050.80**

Non binding dimensions, expressed in mm.

For a correct usage of the product it is advisable to carry out some preliminary assembling tests to determine the correct hole diameter.

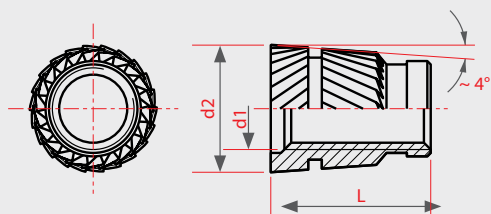

SERIES 853 - 854

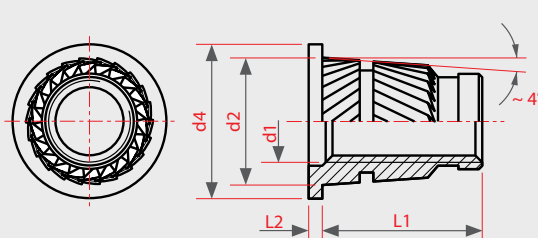
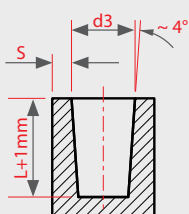

SERIES 855

SERIES INSERT-PLAST NT

WITHOUT SLOT



THREADED EXPANSION INSERTS

APPLICATION	ASSEMBLY
Thermoplastic materials.	by ultrasonic, heat, with hot moulding.
Thermosetting materials.	with hot moulding.

PRODUCT		CODE	Metric thread	Crown diameter	Total length	Number of toothed crowns	Hole diameter*
S**	R***		(d1)	(d2)	(L)		(d3)
	●	M.2 C.03.5 NT	M 2	4	3.5	1	3.2
	●	M.2,5 C.04 NT	M 2.5	4.5	4	1	3.5
●		M.3 C.05 NT	M 3	5.6	5	1	4.7
●		M.3 E.08 NT			8	2	
●		M.3 D.09.5 NT			9.5	2	
	●	M.3,5 C.05 NT	M 3.5	6	5	1	5.1
	●	M.3,5 E.08 NT			8	2	
	●	M.3,5 D.09.5 NT			9.5	2	
●		M.4 C.05 NT	M 4	6.6	5	1	5.6
●		M.4 E.08 NT			8	2	
●		M.4 D.09.5 NT			9.5	2	
●		M.5 C.06 NT	M 5	7.6	6	1	6.8
●		M.5 D.09 NT			9	2	
●		M.6 C.07 NT	M 6	8.6	7	1	7.7
●		M.6 D.09 NT			9	2	
●		M.8 D.10 NT	M 8	10.6	10	2	9.6

S** standard	R*** on demand
-----------------	-------------------

* Hole diameter varies depending on the receiving material.

• MATERIAL

Brass

• FINISHING

Natural

• TOLERANCES

ISO 2768-m

• THREADING d1

ISO 6H

• EXAMPLE OF CODE DESIGNATION

Threaded expansion bushing without slots, M 5 thread, 9 mm length, brass: **M.5 D.09 NT**

ⓘ The upper bevel angle is not usually provided for M 2 and M 2.5 threads.

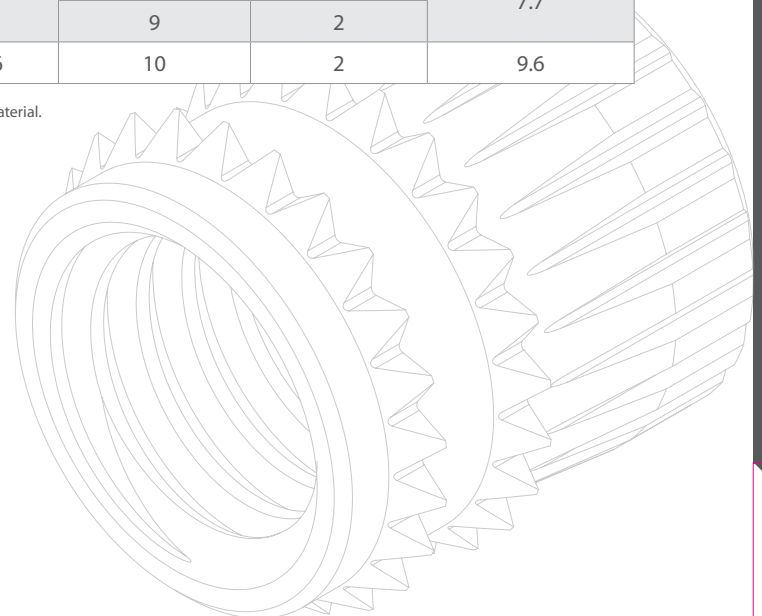

Non binding dimensions, expressed in mm.

For a correct usage of the product it is advisable to carry out some preliminary assembling tests to determine the correct hole diameter.

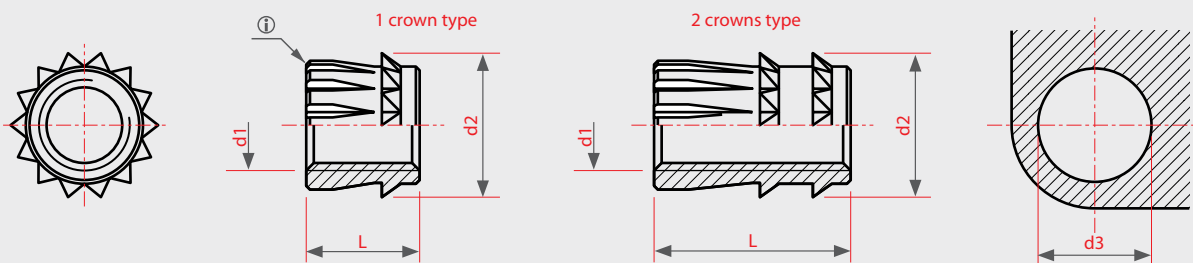

S-Lok® SERIES 866 - 867



THREADED STUDS

APPLICATION	ASSEMBLY
Thermoplastic materials.	Ultrasonic, heat, overmoulding.
Thermosetting materials.	Overmoulding.

SERIES 866

PRODUCT	CODE	Metric thread	External diameter	Anchorage dimension	Hole diameter	Minimum wall thickness	
S**	R***	(d1)	(d2)	(L1)	(d3)	(S)	
	●	866 0020.8_	M 2	3.6	4.0	3.2	2.0
	●	866 0025.8_	M 2.5	4.6	5.8	4.0	2.3
	●	866 0030.8_	M 3	4.6	5.8	4.0	2.3
	●	866 0035.8_	M 3.5	5.4	7.2	4.8	2.5
	●	866 0040.8_	M 4	6.3	8.2	5.6	2.5
	●	866 0050.8_	M 5	7.0	9.5	6.4	2.7
	●	866 0060.8_	M 6	8.6	12.7	8.0	3.0
	●	866 0080.8_	M 8	10.2	12.7	9.6	3.5

AVAILABILITY STUD LENGTH (TABLE 1)

CODE final data	Stud length	M 2 M 2.5	M 3 M 3.5 M 4	M 5 M 6 M 8
_____2	6	●	●	●
_____4	10	●	●	●
_____6	16	●	●	●
_____8	25	●	●	●

THREAD LENGTH L4 = L3 - 2P
P = THREAD PITCH

SERIES 867

PRODUCT	CODE	Metric thread	External diameter	Head diameter	Head thickness	Anchorage dimension	Hole diameter	Minimum wall thickness	
S**	R***	(d1)	(d2)	(d4)	(L2)	(L1)	(d3)	(S)	
	●	867 0020.8_	M 2	3.6	4.8	0.6	4.0	3.2	2.0
	●	867 0025.8_	M 2.5	4.6	5.6	0.6	5.8	4.0	2.3
	●	867 0030.8_	M 3	4.6	5.6	0.6	5.8	4.0	2.3
	●	867 0035.8_	M 3.5	5.4	6.4	0.8	7.2	4.8	2.5
	●	867 0040.8_	M 4	6.3	7.2	0.8	8.2	5.6	2.5
	●	867 0050.8_	M 5	7.0	8.0	1.0	9.5	6.4	2.7
	●	867 0060.8_	M 6	8.6	9.5	1.3	12.7	8.0	3.0
	●	867 0080.8_	M 8	10.2	11.0	1.3	12.7	9.6	3.5

• MATERIAL

Brass

• FINISHING

Natural

• TOLERANCES

ISO 2768-m

• THREADING d1

ISO 6g

• EXAMPLE OF CODE DESIGNATION

Threaded stud S-Lok® with head, M 5 thread, brass, stud length 16 mm: **867 0050.86**

S**	R***
standard	on demand

Non binding dimensions, expressed in mm.

For a correct usage of the product it is advisable to carry out some preliminary assembling tests to determine the correct hole diameter.

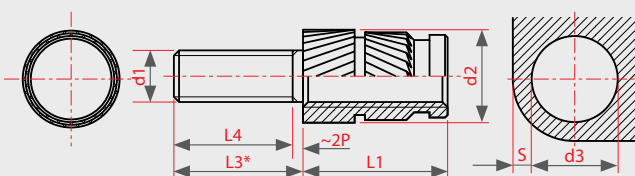

SERIES 866

* stud length L3: see table 1.

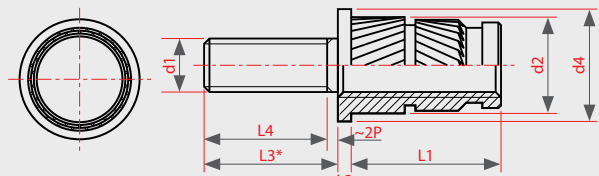

SERIES 867

* stud length L3: see table 1.

S-Lok® SERIES 858 - 859



THREADED STUDS

APPLICATION	ASSEMBLY
Thermoplastic materials.	Ultrasonic, heat, overmoulding.
Thermosetting materials.	Overmoulding.

SERIES 858

PRODUCT		CODE	Metric thread	External diameter	Anchorage dimension	Hole diameter	Minimum wall thickness
S**	R***		(d1)	(d2)	(L1)	(d3 ^{+0.1})	(S)
	●	858 1020.8_	M 2	4.1	5.0	3.8	1.5
	●	858 1025.8_	M 2.5	4.1	5.0	3.8	1.8
	●	858 1030.8_	M 3	4.6	5.5	4.4	1.8
	●	858 1035.8_	M 3.5	5.4	6.0	5.2	1.8
	●	858 1040.8_	M 4	6	7.5	5.8	2.0
	●	858 1050.8_	M 5	7.2	9.0	6.9	2.0
	●	858 1060.8_	M 6	8.8	10.0	8.5	2.5
	●	858 1080.8_	M 8	11.2	12.0	10.9	3.0

AVAILABILITY STUD LENGTH (TABLE 1)

CODE final data	Stud length			
	(L3)	M 2 M 2.5	M 3 M 3.5 M 4	M 5 M 6 M 8
_____ . 2	6	●	●	●
_____ . 4	10	●	●	●
_____ . 6	16	●	●	●
_____ . 8	25	●	●	●

THREAD LENGTH L4 = L3 - 2P
P = THREAD PITCH

SERIES 859

PRODUCT		CODE	Metric thread	External diameter	Head diameter	Head thickness	Anchorage dimension	Hole diameter	Minimum wall thickness
S**	R***		(d1)	(d2)	(d4)	(L2)	(L1)	(d3 ^{+0.1})	(S)
	●	859 1020.8_	M 2	4.1	5.6	0.6	5.0	3.8	1.5
	●	859 1025.8_	M 2.5	4.1	5.6	0.6	5.0	3.8	1.5
	●	859 1030.8_	M 3	4.6	6.4	0.6	5.5	4.4	1.8
	●	859 1035.8_	M 3.5	5.4	7.2	0.8	6.0	5.2	1.8
	●	859 1040.8_	M 4	6	8.0	0.8	7.5	5.8	2.0
	●	859 1050.8_	M 5	7.2	9.0	1.0	9.0	6.9	2.0
	●	859 1060.8_	M 6	8.8	10.0	1.3	10.0	8.5	2.5
	●	859 1080.8_	M 8	11.2	12.5	1.3	12.0	10.9	3.0

• MATERIAL

Brass

• FINISHING

Natural

• TOLERANCES

ISO 2768-m

• THREADING d1

ISO 6g

• EXAMPLE OF CODE DESIGNATION

Threaded stud S-Lok® with head, M5 thread, brass, stud length 16 mm: **859 1050.86**

S** standard	R*** on demand
-----------------	-------------------

Non binding dimensions, expressed in mm.

For a correct usage of the product it is advisable to carry out some preliminary assembling tests to determine the correct hole diameter.

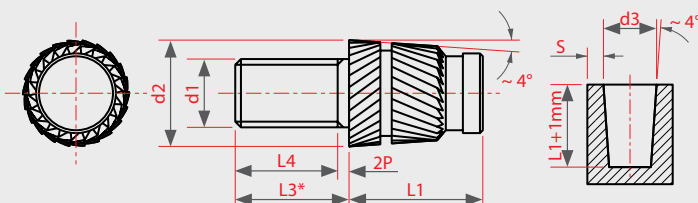

SERIES 858

* stud length L3: see table 1.

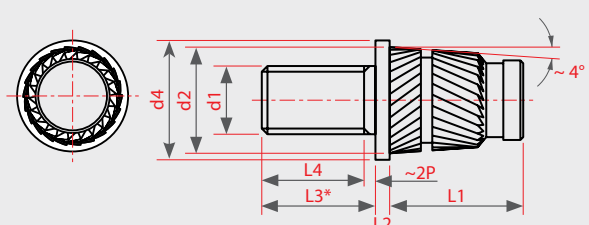

SERIES 859

* stud length L3: see table 1.

SERIES 60_/C - 62_/C

BLIND THREADED INSERTS

APPLICATION	ASSEMBLY
Thermoplastic materials.	Ultrasonic, heat, overmoulding.
Thermosetting materials.	Overmoulding.



SERIES 60_/C

PRODUCT		CODE	Metric thread	External diameter	Total length	Hole diameter	Minimum wall thickness
S**	R***		(d1)	(d2)	(L)	(d3)	(S)
●		603/C	M 3	4.6	8.8	4.0	2.3
●		604/C	M 4	6.3	12.2	5.6	2.5
●		605/C	M 5	7.0	15	6.4	2.7
●		606/C	M 6	8.6	15	8.0	3.0
●		608/C	M 8	10.2	15	9.6	3.5

S** standard	R*** on demand
-----------------	-------------------



SERIES 62_/C

PRODUCT		CODE	Metric thread	External diameter	Head diameter	Head thickness	Anchorage dimension	Hole diameter	Minimum wall thickness
S**	R***		(d1)	(d2)	(d4)	(L2)	(L1)	(d3)	(S)
	●	623/C	M 3	4.6	5.6	0.6	8.8	4.0	2.3
	●	624/C	M 4	6.3	7.2	0.8	12.2	5.6	2.5
	●	625/C	M 5	7.0	8.0	1.0	15	6.4	2.7
	●	626/C	M 6	8.6	9.5	1.3	15	8.0	3.0
	●	628/C	M 8	10.2	11.0	1.3	15	9.6	3.5

- **MATERIAL**
Brass
- **FINISHING**
Natural
- **TOLERANCES**
ISO 2768-m
- **THREADING d1**
ISO 6H
- **EXAMPLE OF CODE DESIGNATION**
Closed insert S-Lok® with head, M 5 thread, brass: 625/C

S** standard	R*** on demand
-----------------	-------------------

Non binding dimensions, expressed in mm.

For a correct usage of the product it is advisable to carry out some preliminary assembling tests to determine the correct hole diameter.

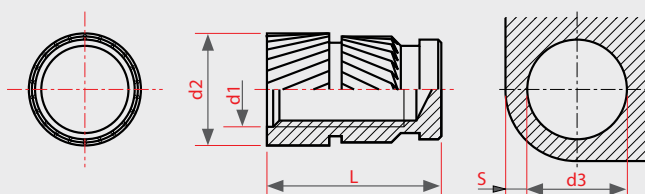

SERIES 60_/C

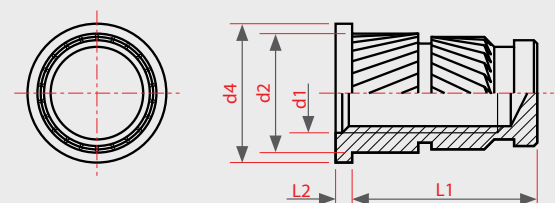

SERIES 62_/C

SERIES ES



HEXAGONAL THREADED INSERTS

APPLICATION

Thermoplastic materials and thermosetting materials.

ASSEMBLY

Overmoulding.

PRODUCT		CODE	Metric thread	ch	Total length	d2	L1	Type
S**	R***		(d1)		(L)			
	●	ES M3 H04.5	M 3	5	4.5	4	1	1
	●	ES M3 H06	M 3	5	6	4	1	2
●		ES M4 H06	M 4	6	6	5.5	1	1
●		ES M4 H08	M 4	6	8	5.5	1	2
●		ES M5 H07.5	M 5	7	7.5	7	1	1
●		ES M5 H10	M 5	7	10	7	1	2
●		ES M6 H09	M 6	9	9	8	1	1
●		ES M6 H12	M 6	9	12	8	1	2
●		ES M8 H12	M 8	11	12	10	1	1
●		ES M8 H16	M 8	11	16	10	1	2
	●	ES M10 H15	M 10	14	15	12.5	1	1
	●	ES M10 H20	M 10	14	20	12.5	1	2

S** standard	R*** on demand
-----------------	-------------------

• MATERIAL

Brass

• FINISHING

Natural

• TOLERANCES

ISO 2768-m

• THREADING d1

ISO 6H metric

• EXAMPLE OF CODE DESIGNATION

Hexagonal bush, M 6 thread, length 12 mm, brass: **ES M6 H12**

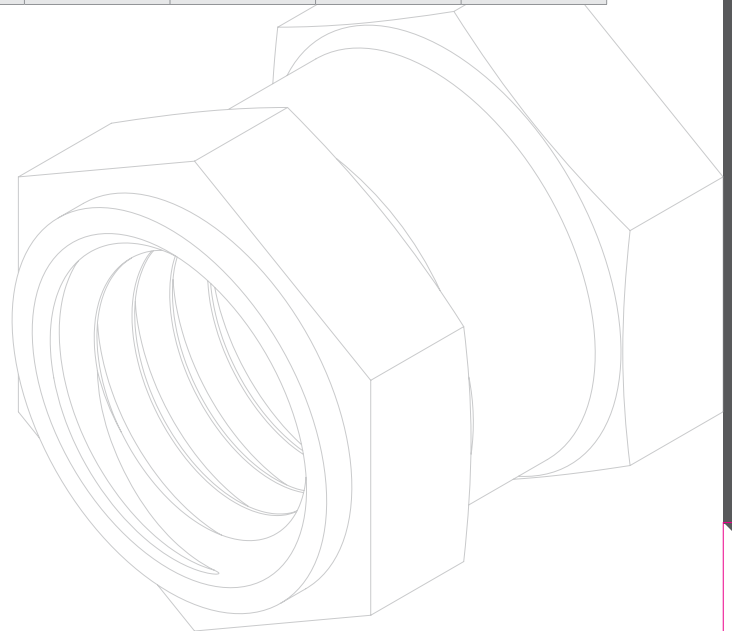

Non binding dimensions, expressed in mm.

For a correct usage of the product it is advisable to carry out some preliminary assembling tests to determine the correct hole diameter.

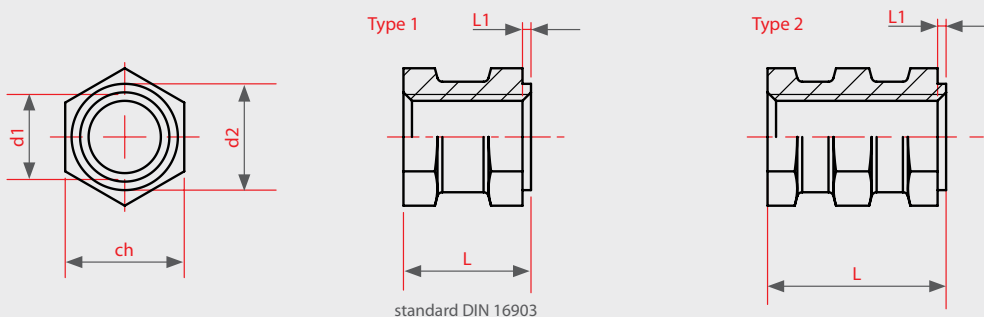

SERIES ES CH

BLIND HEXAGONAL THREADED INSERTS



APPLICATION

Thermoplastic materials and thermosetting materials.

ASSEMBLY

Overmoulding.

PRODUCT		CODE	Metric thread	ch	Total length	d2	L1	Type
S**	R***		(d1)		(L)			
	●	ES M3 H04.5 CH	M 3	5	4.5	4	1	1
	●	ES M3 H06 CH	M 3	5	6	4	1	2
●		ES M4 H06 CH	M 4	6	6	5.5	1	1
●		ES M4 H08 CH	M 4	6	8	5.5	1	2
●		ES M5 H07.5 CH	M 5	7	7.5	7	1	1
●		ES M5 H10 CH	M 5	7	10	7	1	2
●		ES M6 H09 CH	M 6	9	9	8	1	1
●		ES M6 H12 CH	M 6	9	12	8	1	2
●		ES M8 H12 CH	M 8	11	12	10	1	1
●		ES M8 H16 CH	M 8	11	16	10	1	2
	●	ES M10 H15 CH	M 10	14	15	12.5	1	1
	●	ES M10 H20 CH	M 10	14	20	12.5	1	2

S** standard	R*** on demand
-----------------	-------------------

- **MATERIAL**
Brass
- **FINISHING**
Natural
- **TOLERANCES**
ISO 2768-m
- **THREADING d1**
ISO 6H metric
- **EXAMPLE OF CODE DESIGNATION**
Closed hexagonal bush, M 6 thread, length 12 mm, brass: **ES M6 H12 CH**

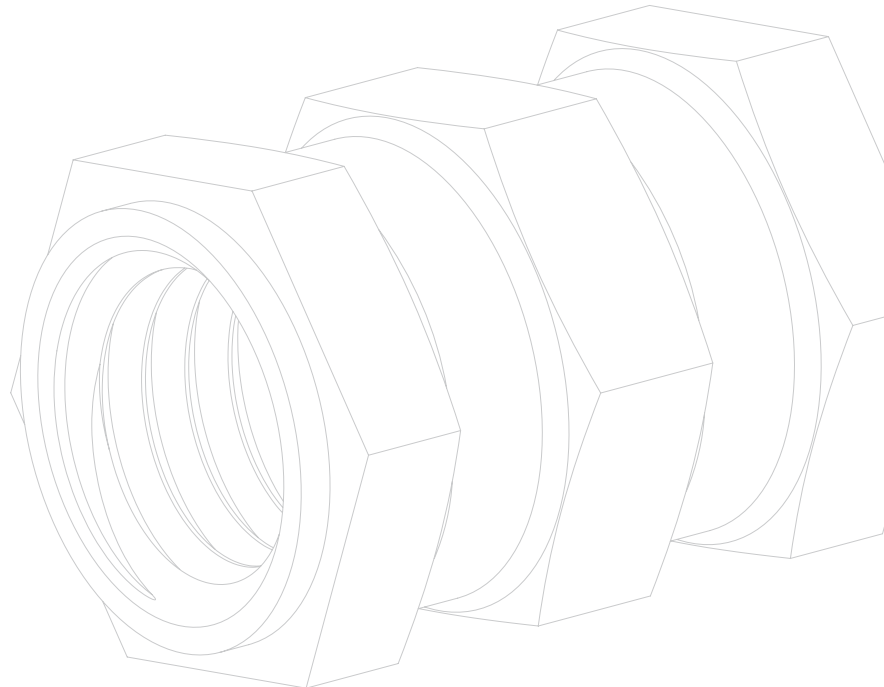

Non binding dimensions, expressed in mm.

For a correct usage of the product it is advisable to carry out some preliminary assembling tests to determine the correct hole diameter.

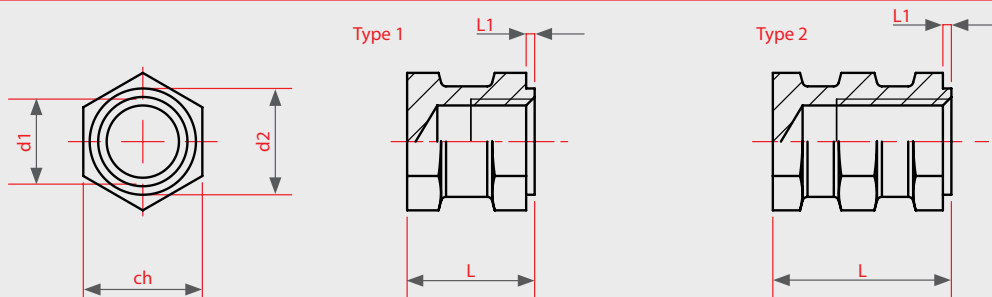

SELF-TAPPING INSERTS

Features and benefits

The **Ensats**® is a self-tapping metal insert, with internal and external thread and slots or holes providing a tapping effect.

The **Ensats**® bush is inserted into materials with low resistance (all types of plastics, thermosets, thermoplastics, fibreglass, reinforced plastics and resins) requiring threaded seats with high specifications of resistance and wear. It can also be inserted into metals (such as light alloys, castings). Refer to the **Ensats**® catalogue for the specifications of these applications. Can also be used for re-tapping worn thread.

The **Ensats**® 302 bush (with tapping grooves) is ideal for use with most applications. The **Ensats**® bush may create a slight self-locking effect with some materials. If this is not required, we recommend the **Ensats**® 307-308 series (with tapping holes), whose shape is ideal for materials that are particularly resistant to cutting.

The **Ensats**® 305 series (with lengthwise grooves) supports high loads thanks to its special section. Preferably for use with thermosets.

The **Ensats**® 307, series is short and compact and is particularly suitable for low thicknesses.

The **Ensats**® bush can be used for all machining and processing of plastics.

The **Ensats**® bush has a large cutting surface and therefore offers greater resistance to traction. It can be inserted into the finished item, which means higher efficiency for machining centres and the elimination of positioning errors or material deposited in the thread.

A casting hole or tool with standard tolerances is all that is needed to fit **Ensats**® bushes.

Its fast and easy fitting make the system extremely cost effective.

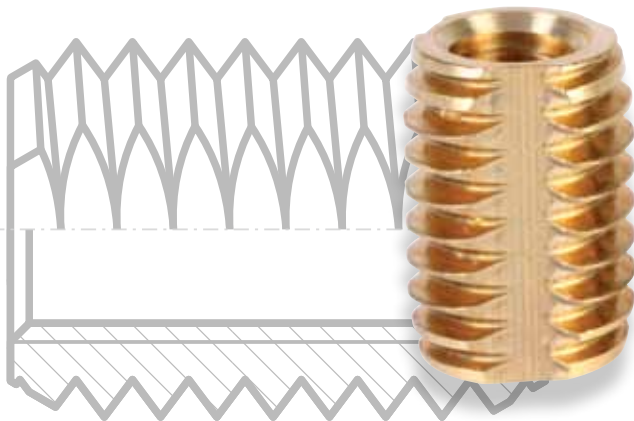

APPROXIMATE MAXIMUM RESISTANCE RATINGS COMPARED TO OTHER FASTENING SYSTEMS

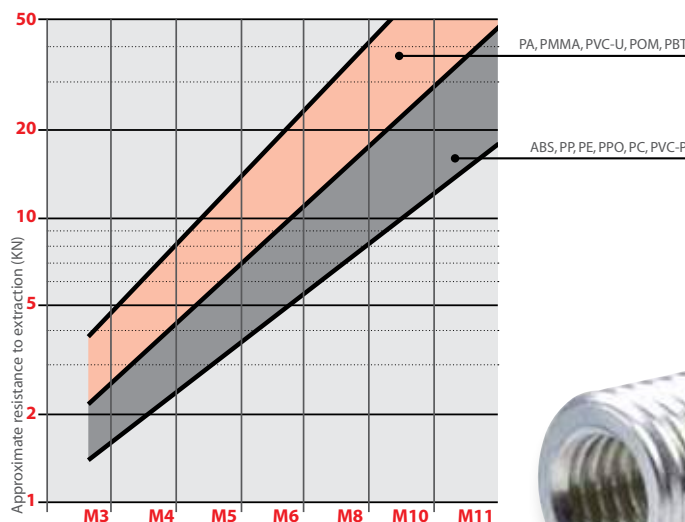

Ensats® internal thread



PREPARATION OF THE SEAT

The hole can be created during moulding or by a machine tool. In order to prevent cracks or marks, prepare the lead-in area of the hole as follows:

- for soft plastics, flare by 60°
- for hard or fragile plastics, create a groove $N = d_2 + 0,2$ at 0,4 mm.

The depth must be the same as the pitch of the external thread, or more. Take care not to alter the shape of the surface of the item when inserting the **Ensats**.

Passing hole: the length of the **Ensats** must not exceed the thickness of the material (**M**).

Dummy hole: the minimum depth (**T**) is indicated in the datasheet for each product.

Hole walls: the minimum thickness required (**W**) depends on the envisaged load and the elasticity of the material where the **Ensats** bush is inserted.

Hole diameter: hard, resistant materials require larger holes compared to soft, elastic materials. The specifications are indicated on the datasheets for each product. The **Ensats** bush must be fitted at least

APPROXIMATE W VALUES FOR PLASTICS

greater/equal 0,25 at 0,9 d2

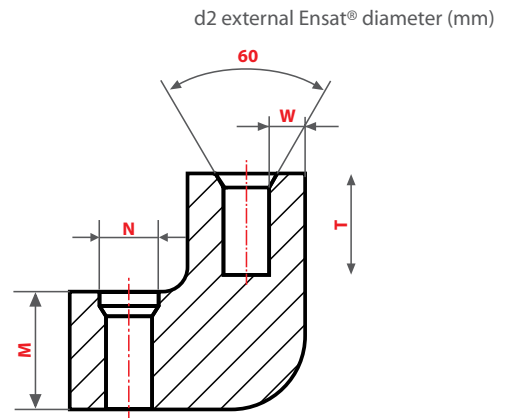

0,1-0,2 mm below the assembly surface. The perforation diameter is calculated according to the material and the **Ensats** bush. Larger holes mean easier insertion but can be detrimental for resistance to traction. Testing the assembly is therefore recommended

TOOLS

Use **610** manual tools and the use of a tap wrench and spanner. Use tool **620** or **621** for fitting on:

- 1) tapping machines or machining centres; no guide; no advancement. Never pass the maximum moment.
- 2) special hand-operated machines; stops in depth or return; lubrication only for materials resistant to cutting.

INTERNAL THREAD	MIN. RPM	MAXIMUM MOMENT ALLOWED	
M 2.5 - M 3	800 - 1300	Ensats® M 2.5	Nm 1.5
M 4 - M 5	600 - 900	Ensats® M 3	Nm 2.5
M 6 - M 8	400 - 700	Ensats® M 4	Nm 5.5
M 10 - M 12	300 - 450	Ensats® M 5	Nm 10
M 14 - M 16	240 - 350	Ensats® M 6	Nm 15
M 18 - M 20	180 - 300	Ensats® M 8	Nm 28
M 22 - M 24	160 - 250	Ensats® M 10	Nm 40
M 27 - M 30	140 - 200	Ensats® M 12	Nm 60

Approximate values per rpm (light metals).

ENSAT® INSERTION BY MACHINE

Adjust the position of the chuck with respect to the bush. The **Ensats** machine tool must be fitted on tapping machines or drills with reverse travel. Put the receiving item into the correct position, respecting the common axis of the hole/chuck. Adjust the end limit so that the **Ensats** bush is 0.1- 0.2 mm below the assembly surface after fitting. If there are any studs, they must rest on the bottom of the hole. Select the operating speed. At the beginning of the insertion stage, the body of the tool must have the insertion pin as shown in the illustration. Screw about 3 turns of the **Ensats** bush onto the tool with the grooves or holes facing downwards. Bring the **Ensats** bush adjacent to the receiving item. The advancement and

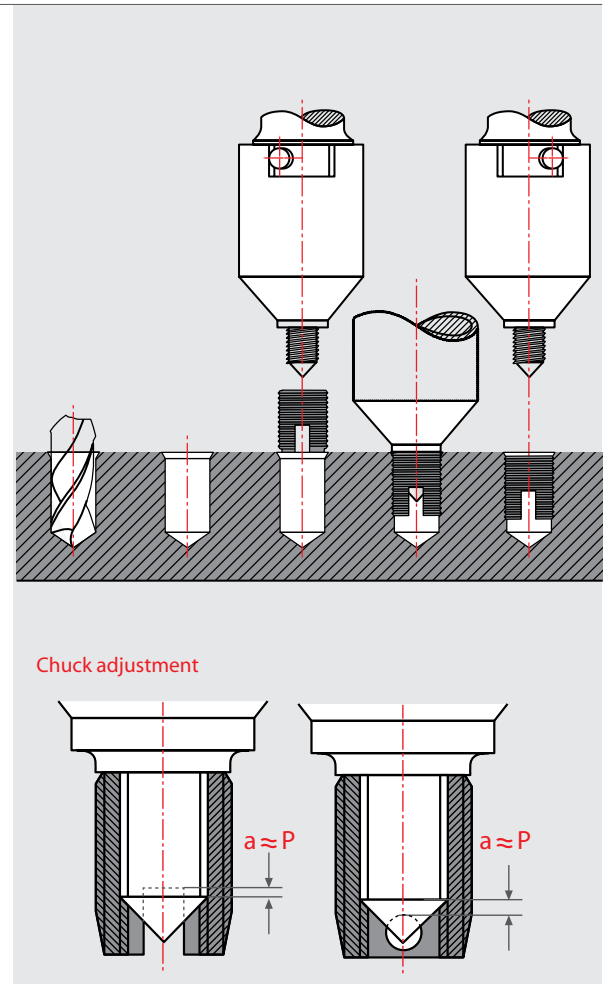

insertion will take place by inertia, without the need for automatic advancement. Change the direction of rotation to remove the tool. The advancement must be gradual to avoid the "hard" impact of the tool on the item as this could cause component breakage or be detrimental to the fastening.

TOOL 610 FOR MANUAL INSTALLATION

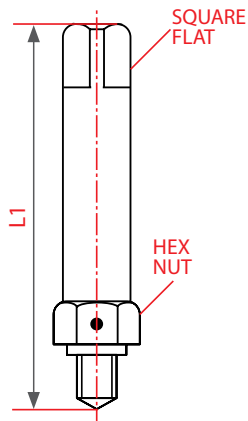

TOOL FOR ENSAT®	CODE	L1	Square Flat	Hex nut
M 2.5 x 0.45	610 0025.00	55	5	7
M 3 x 0.5	610 0030.00	55	5	7
M 3.5 x 0.6	610 0035.00	55	5	7
M 4 x 0.7	610 0040.00	60	5	7
M 5 x 0.8	610 0050.00	75	8	13
M 6 x 1	610 0060.00	75	8	13
M 8 x 1.25	610 0080.00	75	8	13
M 10 x 1.5	610 0100.00	95	12.5	19
M 12 x 1.75	610 0120.00	95	12.5	19
M 14 x 2	610 0140.00	95	12.5	19

TOOL 620 FOR MACHINE INSTALLATION

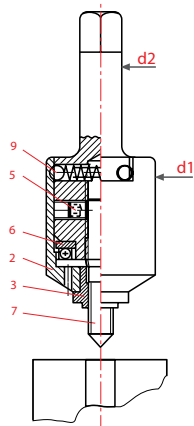

Set or exchange the stud

Pull off the shell (2) downwards off the shaft (1). Release the locking screw (5). Screw the stud (7) in or out. Yellow colour marking indicates the flattened surfaces for the locking screws. When assembling, tighten both screws (5) evenly. Insert the ball bearing (6). Push on the shell (2) until the ball stop locks into place. To ensure that the tool functions perfectly, it must be possible to easily rotate the shell.

TOOL FOR ENSAT®	CODE	d1	d2	Square Flat	Total length (ca)
M 2.5 x 0.45	620 0025.00	18	8	6.3	82
M 3 x 0.5	620 0030.00	18	8	6.3	82
M 3.5 x 0.6	620 0035.00	18	8	6.3	78
M 4 x 0.7	620 0040.00	18	8	6.3	83
M 5 x 0.8	620 0050.00	24	12.5	10	101
M 6 x 1	620 0060.00	24	12.5	10	102
M 8 x 1.25	620 0080.00	24	12.5	10	105
M 10 x 1.5	620 0100.00	32	16	12.5	131
M 12 x 1.75	620 0120.00	32	16	12.5	134
M 14 x 2	620 0140.00	50	25	20	166
M 16 x 2	620 0160.00	50	25	20	166
M 18 x 2.5	620 0180.00	50	25	20	166
M 20 x 2.5	620 0200.00	58	25	20	195
M 22 x 2.5	620 0220.00	58	25	20	195
M 24 x 3	620 0240.00	70	30	25	220
M 27 x 3	620 0270.00	70	30	25	220
M 30 x 3.5	620 0300.00	70	30	25	220

TOOL 621 FOR DEEP RECEIVING HOLES

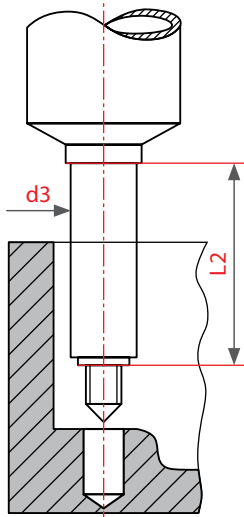

TOOL FOR ENSAT®	CODE	L2	d3
M 2.5 x 0.45	621 0025.00	40	7
M 3 x 0.5	621 0030.00	40	7
M 3.5 x 0.6	621 0035.00	40	7
M 4 x 0.7	621 0040.00	40	7
M 5 x 0.8	621 0050.00	50	9
M 6 x 1	621 0060.00	50	10
M 8 x 1.25	621 0080.00	50	12
M 10 x 1.5	621 0100.00	60	15
M 12 x 1.75	621 0120.00	60	18
M 14 x 2	621 0140.00	60	20
M 16 x 2	621 0160.00	60	22
M 18 x 2.5	621 0180.00	60	24
M 20 x 2.5	621 0200.00	60	26
M 22 x 2.5	621 0220.00	60	28
M 24 x 3	621 0240.00	60	32
M 27 x 3	621 0270.00	60	35
M 30 x 3.5	621 0300.00	60	38

Ensats® SERIES 302



APPLICATION

On metal alloys, all types of plastics, thermosets, thermoplastics, glass fiber, reinforced plastics, resins, castings.

ASSEMBLY

By special equipment.

PRODUCT		CODE	Metric thread	Special external thread		Length	Diameter (d3)		Min. hole depth
S**	R***		(d1)	(d2)	(P)	(L)	Soft plastics	Hard, brittle plastics	
●		302 0020.__*	M 2	4.5	0.5	6	4.1	4.1 - 4.2	8
●		302 0025.__*	M 2.5	4.5	0.5	6	4.1	4.1 - 4.2	8
●		302 0030.__*	M 3	5	0.5	6	4.6	4.6 - 4.7	8
●		302 0035.__*	M 3.5	6	0.75	8	5.4	5.5 - 5.6	10
●		302 0040.__	M 4	6.5	0.75	8	5.9 - 6.0	6.0 - 6.1	10
●		302 0050.__	M 5	8	1	10	7.2 - 7.3	7.3 - 7.5	13
●		302 0061.__	M 6	9	1	12	8.2 - 8.3	8.3 - 8.5	15
●		302 0060.__	M 6	10	1.5	14	8.8 - 9.0	9.0 - 9.2	17
●		302 0080.__	M 8	12	1.5	15	10.8 - 11.0	11.0 - 11.2	18
●		302 0100.__	M 10	14	1.5	18	12.8 - 13.0	13.0 - 13.2	22
●		302 0120.__	M 12	16	1.5	22	14.8 - 15.0	15.0 - 15.2	26
●		302 0140.__	M 14	18	1.5	24	16.8 - 17.0	17.0 - 17.2	28
●		302 0160.__	M 16	20	1.5	22	18.8 - 19.0	19.0 - 19.2	27
●		302 0180.__	M 18	22	1.5	24	20.8 - 21.0	21.0 - 21.2	29
●		302 0200.__	M 20	26	1.5	27	24.8 - 25.0	25.0 - 25.2	32
●		302 0220.__	M 22	26	1.5	30	24.8 - 25.0	25.0 - 25.2	36
●		302 0240.__	M 24	30	1.5	30	28.8 - 29.0	29.0 - 29.2	36
●		302 0270.__	M 27	34	1.5	30	32.8 - 33.0	33.0 - 33.2	36
●		302 0300.__	M 30	36	1.5	40	34.8 - 35.0	35.0 - 35.2	46

S** standard	R*** on demand
-----------------	-------------------

* Use only with soft materials otherwise the mandrel resistance could be insufficient.

• MATERIAL

- Steel ----- .16
- Ferritic stainless steel 1.4105 (Up to M16) ----- .40
- Austenitic stainless steel 1.4305 (Up to M20) ----- .50
- Brass (Up to M16) ----- .80

• FINISHING

- Steel bushings zinc-plated
- Stainless steel bushings natural
- Brass bushings natural

• TOLERANCES

ISO 2768 - m

• THREADING d1

ISO 6H metric

• EXAMPLE OF CODE DESIGNATION

Self-tapping Ensats® series 302, M5 thread, zinc-plated steel: **302 0050.16**

Rm = ultimate tensile strength N/mm²

HB = Brinell hardness

Other METRIC, UNC, UNF, WHITWORTH threads are available on demand.

Non binding dimensions, expressed in mm.

For a correct usage of the product it is advisable to carry out some preliminary assembling tests to determine the correct hole diameter.

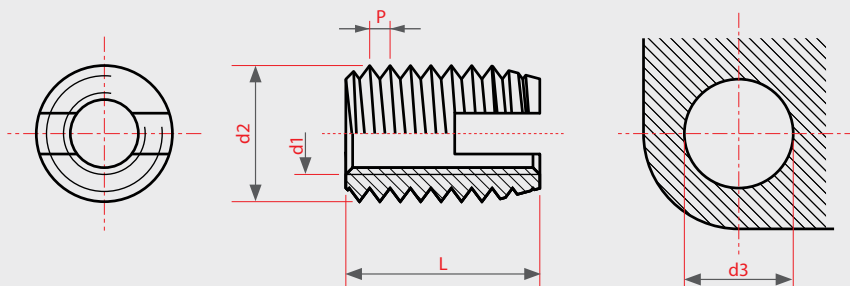

Ensat® SERIES 303



APPLICATION

On metal alloys, all types of plastics, thermosets, thermoplastics, glass fiber, reinforced plastics, resins, castings.

ASSEMBLY

By special equipment.

PRODUCT		CODE	Metric thread	Special external thread		Total Length	Diameter (d3)		Min. hole depth
S**	R***		(d1)	(d2)	(P)	(L)	Soft plastics	Hard, brittle plastics	
●		303 0030.____	M 3	4.5	0.5	6	4.0 - 4.1	4.1 - 4.2	8
	●	303 0035.____	M 3.5	5	0.6	6	4.5 - 4.6	4.6 - 4.7	8
●		303 0040.____	M 4	6	0.7	6	5.3 - 5.4	5.5 - 5.6	8
●		303 0050.____	M 5	7	0.8	8	6.3 - 6.4	6.5 - 6.6	10
●		303 0060.____	M 6	8	1.0	10	7.1 - 7.2	7.3 - 7.5	13
●		303 0080.____	M 8	10	1.25	12	8.6 - 8.8	8.9 - 9.2	15
●		303 0100.____	M 10	12	1.5	15	10.6 - 10.8	10.9 - 11.2	18

S**	R***
standard	on demand

• MATERIAL

Steel		----- .16
Ferritic stainless steel	1.4105	----- .40 (on demand)
<i>((thread excluded M 3.5))</i>		
Austenitic stainless steel	1.4305	----- .50 (on demand)
<i>(M 3.5 - M 8 - M 10 threads excluded)</i>		
Brass		----- .80 (on demand)
<i>(M 3.5 - M 8 - M 10 threads excluded)</i>		

• FINISHING

Steel bushings	zinc-plated
Stainless steel bushings	natural
Brass bushings	natural

• TOLERANCES

ISO 2768 - m

• THREADING d1

ISO 6H metric

• EXAMPLE OF CODE DESIGNATION

Self-tapping Ensat® series 302, M 5 thread, zinc-plated steel: **303 0050.16**

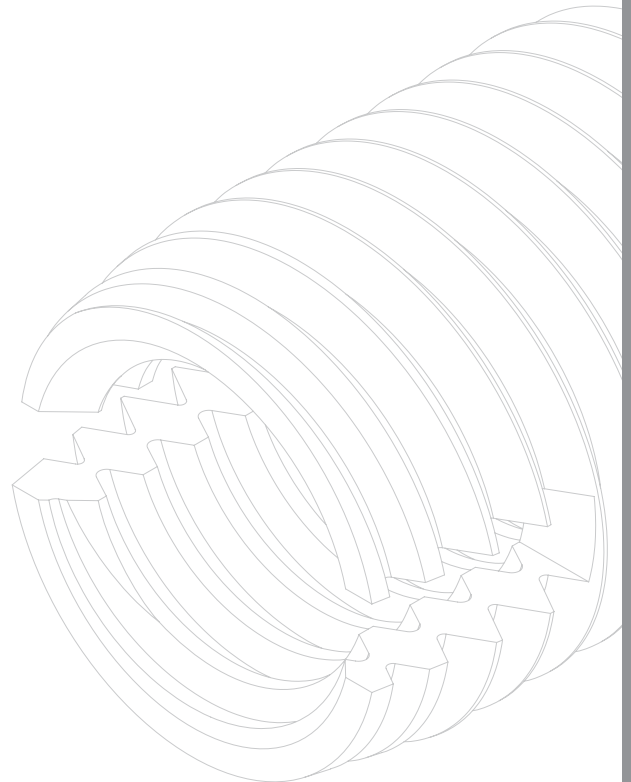

Non binding dimensions, expressed in mm.

For a correct usage of the product it is advisable to carry out some preliminary assembling tests to determine the correct hole diameter.

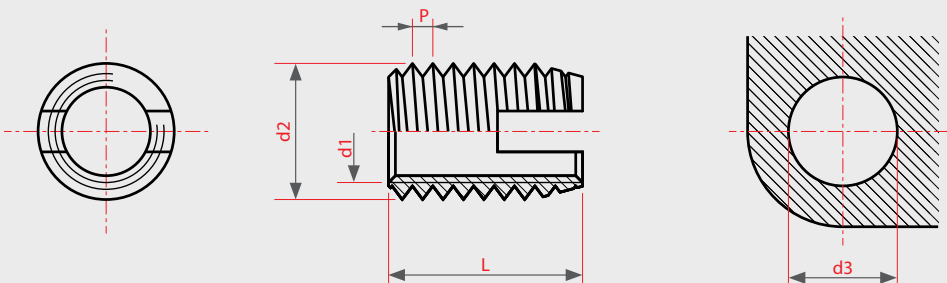

Ensat® SERIES 305

APPLICATION

Soft thermoplastic materials

ASSEMBLY

By special equipment.



PRODUCT		CODE	Metric thread	Special external thread		Total Length	Diameter	Min. hole depth
S**	R***		(d1)	(d2)	(P)	(L)	(d3)	
●		305 0030.80	M 3	5	0.5	6	4.6 - 4.7	7
●		305 0040.80	M 4	6.5	0.75	8	6.0 - 6.1	9
●		305 0050.80	M 5	8	1	10	7.3 - 7.4	11
●		305 0060.80	M 6	10	1.5	14	9.0 - 9.2	15

S** standard	R*** on demand
-----------------	-------------------

• **MATERIAL**

Brass ----- .80

• **FINISHING**

Natural

• **TOLERANCES**

ISO 2768 - m

• **THREADING d1**

ISO 6H metric

• **EXAMPLE OF CODE DESIGNATION**

Self-tapping Ensat® series 305, M 5 thread, brass bushing: **305 0050.80**

Other threads UNC, UNF, WHITWORTH available on demand.

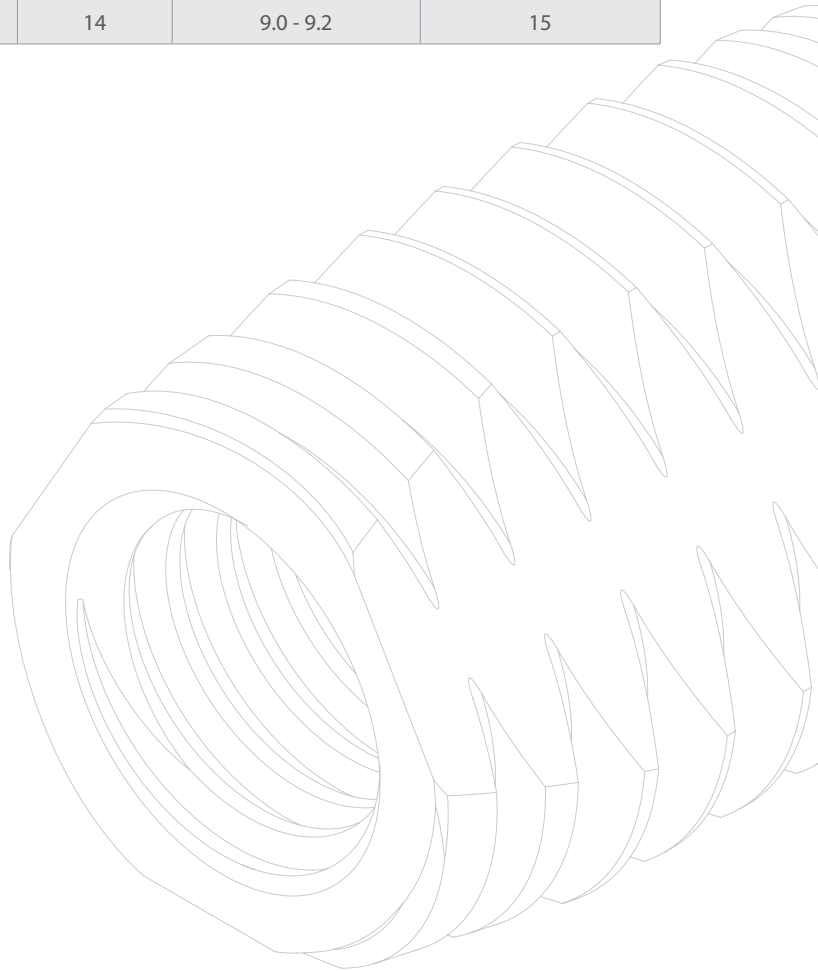

Non binding dimensions, expressed in mm.

For a correct usage of the product it is advisable to carry out some preliminary assembling tests to determine the correct hole diameter.

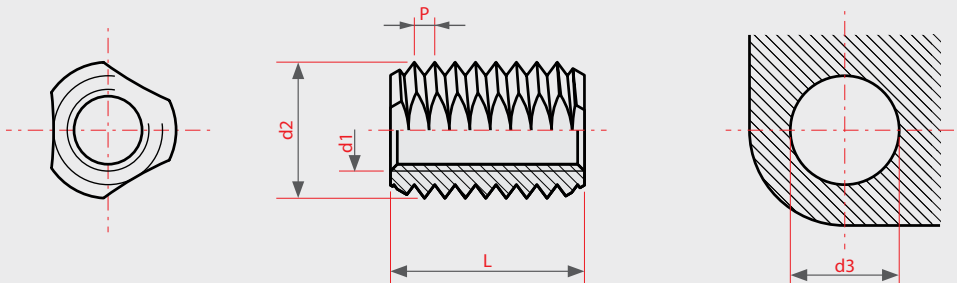

Ensat® SERIES 307-308



APPLICATION

On metal alloys, all types of plastics, thermosets, thermoplastics, glass fiber, reinforced plastics, resins, castings.

ASSEMBLY

By special equipment.

PRODUCT		CODE	Metric thread	Special external thread		Total Length	Diameter (d3)		Min. hole depth
S**	R***			(d1)	(d2)		(P)	(L)	
●		307 0030.____	M 3	5	0.6	4	4.6 - 4.7	4.7	6
●		308 0030.____				6			8
●		307 0035.____	M 3.5	6	0.8	5	5.5 - 5.6	5.6	7
●		308 0035.____				8			10
●		307 0040.____	M 4	6.5	0.8	6	6.0 - 6.1	6.1	8
●		308 0040.____				8			10
●		307 0050.____	M 5	8	1	7	7.4 - 7.5	7.5 - 7.6	9
●		308 0050.____				10			13
●		307 0060.____	M 6	10	1.25	8	9.3 - 9.4	9.4 - 9.5	10
●		308 0060.____				12			15
●		307 0080.____	M 8	12	1.5	9	11.1 - 11.2	11.2 - 11.3	11
●		308 0080.____				14			17
●		307 0100.____	M 10	14	1.5	10	13.1 - 13.2	13.2 - 13.3	13
●		308 0100.____				18			22
●		307 0120.____	M 12	16	1.75	12	15.0 - 15.1	15.1 - 15.2	15
●		308 0120.____				22			26
●		307 0140.____	M 14	18	2	14	17.0 - 17.1	17.1 - 17.2	17
●		308 0140.____				24			28
●		307 0160.____	M 16	20	2	14	19.0 - 19.1	19.1 - 19.2	17
●		308 0160.____				24			28

MATERIAL

Steel ----- .16
 Ferritic stainless steel 1.4105 (up to M14) ----- .40
 Austenitic stainless steel 1.4305 (up to M12) ----- .50

FINISHING

Steel bushings zinc-plated
 Stainless steel bushings natural

TOLERANCES

ISO 2768 - m

THREADING d1

ISO 6H metric

EXAMPLE OF CODE DESIGNATION

Self-tapping Ensat® series 308, M 5 thread,
 zinc-plated steel: **308 0050.16**

S** standard	R*** on demand
-----------------	-------------------

Rm = Ultimate tensile strength N/mm²
 HB = Brinell hardness

Other threads UNC, UNF, WHITWORTH available on demand.

For a correct usage of the product it is advisable to carry out some preliminary assembling tests to determine the correct hole diameter.

Non binding dimensions, expressed in mm.

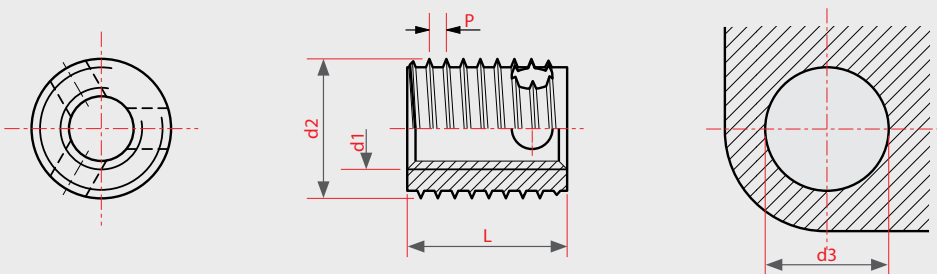

Ensat® SERIES 309



APPLICATION
Soft thermoplastic materials.
ASSEMBLY
By special equipment.

PRODUCT		CODE	Metric thread	Special external thread		Total Length	Diameter (d3)		Min. hole depth
S**	R***			(d1)	(d2)		(P)	Soft plastics	
	●	309 0025.80.____	M 2.5	5	1.6	6	3.5	3.6 - 3.8	8
●		309 0030.80.____	M 3	5.5	1.6	6	4.1	4.2 - 4.3	9
	●	309 0035.80.____	M 3.5	6.5	1.6	8	4.6	4.7 - 4.8	10
●		309 0040.80.____	M 4	7	2.5	10	5.1	5.2 - 5.3	13
●		309 0050.80.____	M 5	9	3	12	6.6	6.7 - 6.9	15
●		309 0060.80.____	M 6	10	4	14	7.6	7.7 - 7.9	17
●		309 0080.80.____	M 8	13	4	20	9.9	10.1 - 10.3	23
●		309 0100.80.____	M 10	16	5	23	12.4	12.6 - 12.8	26
	●	309 0120.80.____	M 12	19	5	26	15.4	15.6 - 15.8	30
	●	309 0140.80.____	M 14	22	5	26	18.4	18.6 - 18.8	30
	●	309 0160.80.____	M 16	24	5	26	20.4	20.6 - 20.8	30

S** standard	R*** on demand
------------------------	--------------------------

- **MATERIAL**
Brass
- **FINISHING**
Natural
- **TOLERANCES**
ISO 2768 - m
- **THREADING d1**
ISO 6H metric
- **EXAMPLE OF CODE DESIGNATION**
Self-tapping bushings Ensat® series 309, M 5 thread, brass: **309 0050.80**

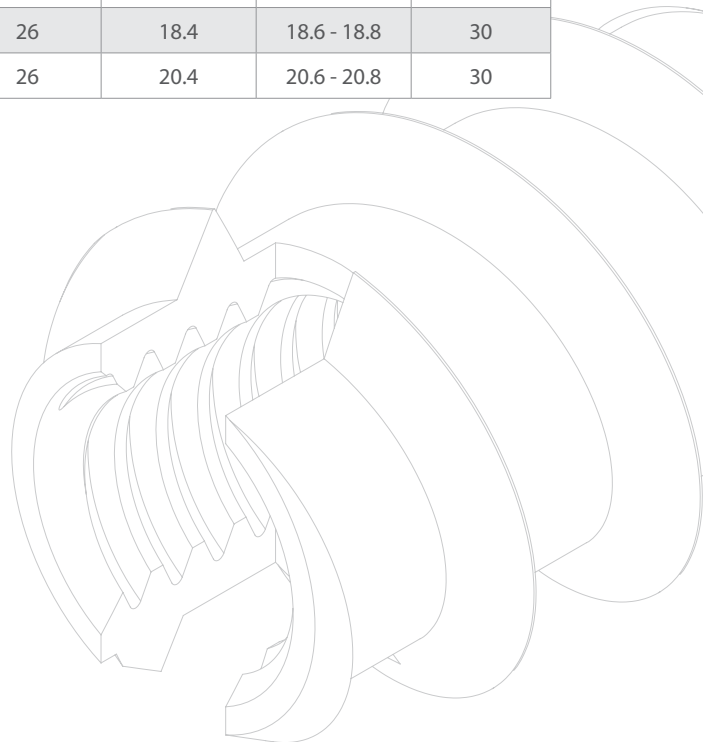

Non binding dimensions, expressed in mm.

For a correct usage of the product it is advisable to carry out some preliminary assembling tests to determine the correct hole diameter.

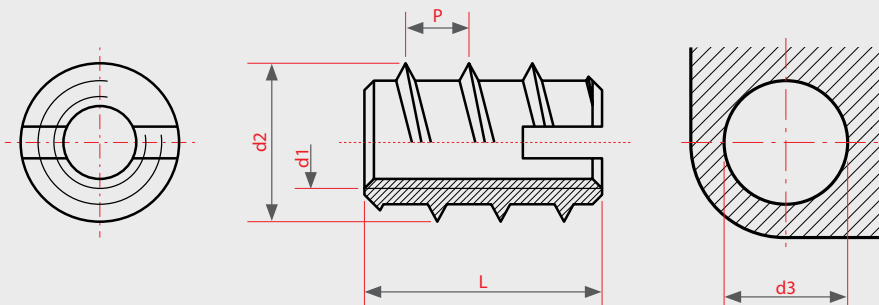

Ensat® SERIES 337 - 338



APPLICATION

On metal alloys, all types of plastics, thermosets, thermoplastics, glass fiber, reinforced plastics, resins, castings.

ASSEMBLY

By special equipment.

PRODUCT		CODE	Metric thread	Special external thread		Total Length	Diameter (d3)		Min. hole depth
S**	R***		(d1)	(d2)	(P)	(L)	Soft plastics	Hard, brittle plastics	
	●	337 0030.____	M 3	5	0.6	4	4.6 - 4.7	4.7	6
	●	338 0030.____				6			8
	●	337 0035.____	M 3.5	6	0.8	5	5.5 - 5.6	5.6	7
	●	338 0035.____				8			10
	●	337 0040.____	M 4	6.5	0.8	6	6.0 - 6.1	6.1	8
	●	338 0040.____				8			10
	●	337 0050.____	M 5	8	1	7	7.4 - 7.5	7.5 - 7.6	9
	●	338 0050.____				10			13
	●	337 0060.____	M 6	10	1.25	8	9.3 - 9.4	9.4 - 9.5	10
	●	338 0060.____				12			15
	●	337 0080.____	M 8	12	1.5	9	11.1 - 11.2	11.2 - 11.3	11
	●	338 0080.____				14			17
	●	337 0100.____	M 10	14	1.5	10	13.1 - 13.2	13.2 - 13.3	13
	●	338 0100.____				18			22
	●	337 0120.____	M 12	16	1.75	12	15.0 - 15.1	15.1 - 15.2	15
	●	338 0120.____				22			26
	●	337 0140.____	M 14	18	2	14	17.0 - 17.1	17.1 - 17.2	17
	●	338 0140.____				24			28
	●	337 0160.____	M 16	20	2	14	19.0 - 19.1	19.1 - 19.2	17
	●	338 0160.____				24			28

• MATERIAL

Steel		_____16
Ferritic stainless steel	1.4105	_____40
Austenitic stainless steel	1.4305	_____50

• FINISHING

Steel bushings	zinc-plated
Stainless bushings	natural

• TOLERANCES

ISO 2768 - m

• THREADING d1

ISO 6 H metric

• EXAMPLE OF CODE DESIGNATION

Self-tapping Ensat® series 338, M 5 thread, zinc-plated steel: **338 0050.16**

Non binding dimensions, expressed in mm.

S** standard	R*** on demand
-----------------	-------------------

Rm = Ultimate tensile strength N/mm²

HB = Brinell hardness

Other threads UNC, UNF, WHITWORTH available on demand.

For a correct usage of the product it is advisable to carry out some preliminary assembling tests to determine the correct hole diameter.

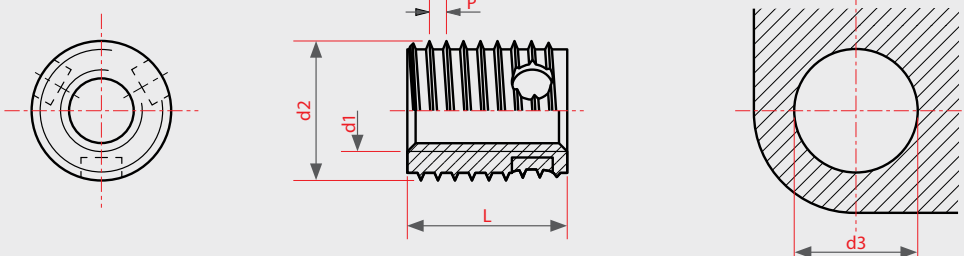

Ensat® SERIES 347 - 348

APPLICATION

On metal alloys, all types of plastics, thermosets, thermoplastics, glass fiber, reinforced plastics, resins, castings.

ASSEMBLY

By special equipment.



PRODUCT		CODE	Metric thread	Special external thread		Total Length	Diameter (d3)		Min. hole depth
S**	R***		(d1)	(d2)	(P)	(L)	Soft plastics	Hard, brittle plastics	
	●	347 0040.____	M 4	6	0.7	6	5.4 - 5.6	5.6 - 5.7	8
	●	348 0040.____				8			10
	●	347 0050.____	M 5	6.5	0.8	7	6.0 - 6.1	6.1 - 6.2	9
	●	348 0050.____				10			13
	●	347 0060.____	M 6	8	1	8	7.4 - 7.6	7.5 - 7.7	10
	●	348 0060.____				12			15
	●	347 0080.____	M 8	10	1.25	9	9.3 - 9.5	9.4 - 9.6	11
	●	348 0080.____				14			17
	●	347 0100.____	M 10	12	1.5	10	11.1 - 11.3	11.2 - 11.5	13
	●	348 0100.____				18			22
	●	347 0120.____	M 12	14	1.75	12	13.1 - 13.3	13.2 - 13.5	15
	●	348 0120.____				22			26

S** standard	R*** on demand
------------------------	--------------------------

• **MATERIAL**

Steel ----- .16
 Ferritic stainless steel 1.4105 ----- .40
 Austenitic stainless steel 1.4305 ----- .50

• **FINISHING**

Steel bushings zinc-plated
 Stainless steel bushings natural

• **TOLERANCES**

ISO 2768 - m

• **THREADING d1**

ISO 6H metric

• **EXAMPLE OF CODE DESIGNATION**

Self-tapping Ensat® series 348, M 5 thread, zinc-plated steel: **348 0050.16**

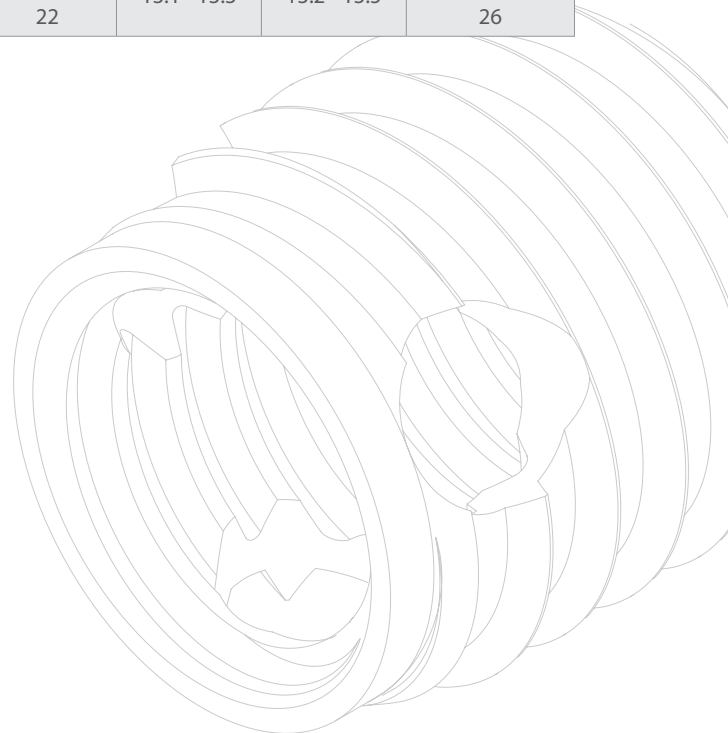

Non binding dimensions, expressed in mm.

For a correct usage of the product it is advisable to carry out some preliminary assembling tests to determine the correct hole diameter.

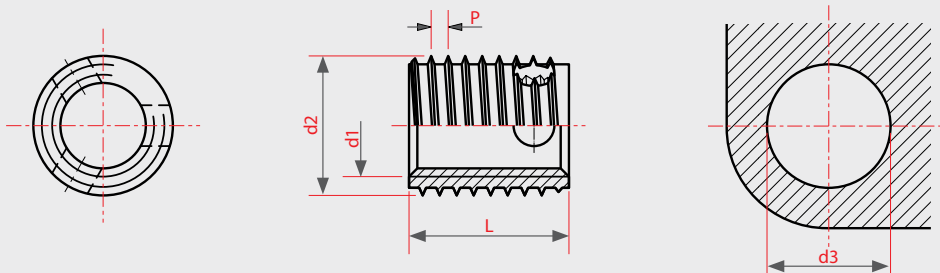

CONVERSION TABLE FOR METRIC/IMPERIAL THREADS

METRIC		WHITWORTH		UNC		UNF	
corresponding to	thread	code	thread	code	thread	code	thread
___030___	M 3	-	-	604	4 - 40	704	4 - 48
___035___	M 3.5	-	-	606	6 - 32	706	6 - 40
___040___	M 4	-	-	608	8 - 32	708	8 - 36
___050___	M 5	-	-	610	10 - 24	710	10 - 32
___060___	M 6	525	1/4	625	1/4" - 20	725	1/4" - 28
___080___	M 8	531	5/16	631	5/16" - 18	731	5/16" - 24
___100___	M 10	537	3/8	637	3/8" - 16	737	3/8" - 24
___120___	M 12	544	7/16	644	7/16" - 14	744	7/16" - 20
___140___	M 14	550	1/2	650	1/2" - 13	750	1/2" - 20
___160___	M 16	562	5/8	662	5/8" - 11	762	5/8" - 18

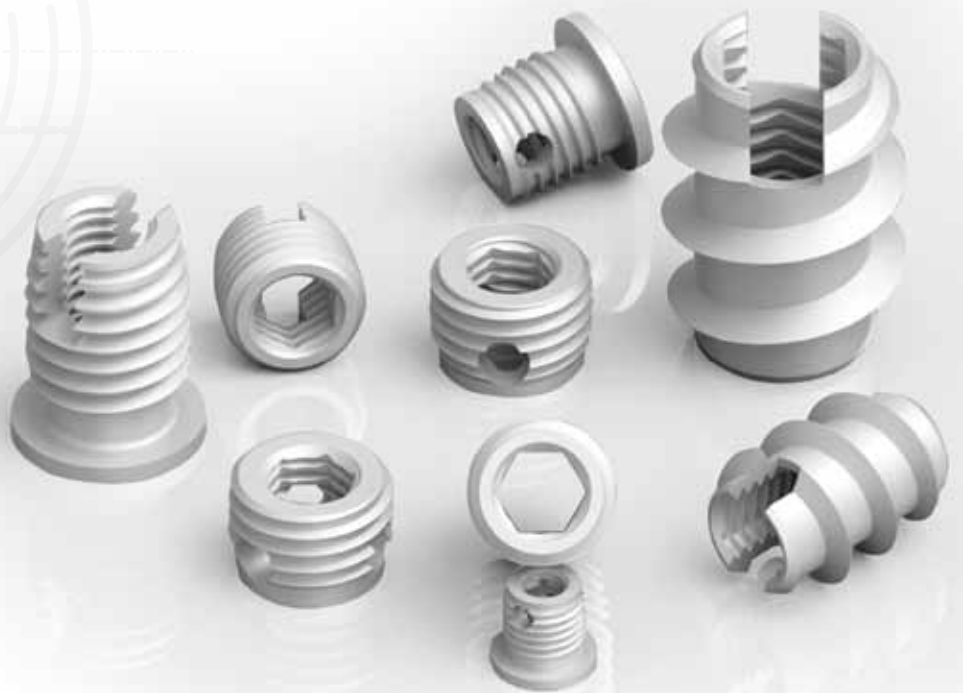

**SPECIAL PRODUCTS ARE AVAILABLE ON REQUEST.
FOR FURTHER INFORMATION PLEASE CONTACT SPECIALINSERT
TECHNICAL DEPARTMENT.**

INSERTS FOR PLASTIC SHEETS

	RUBBER-NUT	NYLON-NUT	FLOWER-NUT
PRODUCT TYPE	Deformation threaded insert	Expansion threaded insert	Deformation threaded insert
PRODUCT LINE	RUBBER-NUT	NYLON-NUT	FLOWER-NUT
THREAD RANGE	M 3 - M 8	M 2.5 - M 8	M 4 - M 8
RECEIVING MATERIAL	Metal sheets and others, thermoplastic, thermosetting plastic, composite	Metal sheets and others, thermoplastic, thermosetting plastic, composite	Metal sheets and others, thermoplastic, thermosetting plastic, composite
ASSEMBLY	Deformation	Pressed-in and expansion	Deformation
FINISHING	Natural state	Natural state	White zinc plating

RUBBER-NUT



ANTI-VIBRATION RUBBER THREADED INSERTS

Anti-vibration rubber threaded inserts, with an internal vulcanized brass threaded bush. It solves any fastening problems on parts subject to vibrations.

ANTI-VIBRATING NYLON THREADED EXPANSION INSERTS



NYLON-NUT

Anti-vibrating threaded expansion inserts, made of a nylon body and a light-alloy internal nut.

FLOWER-NUT



FLOWER SHAPE DEFORMATION THREADED INSERTS

Deformation threaded inserts. Particularly suggested for assembly on soft laminates, wood, composite and plastic materials.

For more technical information please visit www.specialinsert.it **METAL SHEET** section or contact the Specialinsert technical department.



WHY CHOOSE SPECIALINSERT?

- R&D.
- Continuous assistance.
- Continuous technological innovation.
- Technically qualified sales staff directly employed by the company.
- 360° solutions for all fields, versatility, flexibility and dynamism.
- High specialisation.

Technical assistance is supplied by our sales personnel before, during and after product delivery by giving targeted advice to buy the most suitable fasteners for all purposes.

Our customers know they have someone they can rely on to solve problems: their **Specialinsert** technician.

Various mechanical tests are carried out in our technical laboratory:

- Pull-out tests
- Torque test
- Compression tests
- Hardness tests
- Apparatus inspections
- Statistic process monitoring

SALES ASSISTANCE

Our technical sales staff, directly employed by **Specialinsert**, assess needs and are fully equipped to set up practical demonstrations at your plant.

QUALITY

Specialinsert has an integrated Global Safety & Quality System.

Policies of both systems are seen as an integral, priority part of company management as a whole.

Specialinsert managers periodically update and approve the Quality Assurance & Safety Policy.

R&D

Our Testing laboratory and R&D office are constantly seeking new fastening solutions to provide solutions to customer's requests and to develop their own lines of research.

Specialinsert has filed five patents as a result.



ISO 9001 - Cert. n° 0724

The logo for Specialinsert features a stylized orange 'S' that resembles a keyhole or a mechanical part, followed by the word 'pecialinsert' in a bold, orange, sans-serif font. A thin orange horizontal line is positioned below the text.

Specialinsert

HEADQUARTER AND EXPORT DEPARTMENT

Strada della Pronda 66/6 - 10142 - Tel. +39 011.700.301 r.a. - Fax +39 011.702.947

BRANCH

MILANO - Via E. Cialdini 37 - 20161 - Tel. +39 02.646.84.76 r.a. - Fax +39 02.662.002.75

PRODUCTION DEPARTMENT AND BRANCH

MAERNE DI MARTELLAGO (VE) - Via E. Pavanello 1 - 30030 - Tel. +39 041.503.01.00 r.a. - Fax +39 041.503.01.10

www.specialinsert.it - info@specialinsert.it - export@specialinsert.it